

Sailfish 242 CC Owner's Manual



07/13/2020



Table of Contents



07/13/2020

- 2. Boat Specifications
- 3. Boat Trailer Measurement
- 4. Boat Layout
- 5. Seating Locations
- 6. Boat Safety & Warning Labels
- 8. Boat Safety & Warning Label Locations
- 9. Warning Label Replacement Information
- 10. Boarding Ladder & Unassisted Boarding Situations
- 11. Battery Selector Panel and Wiring
- 12. Breaker Panel Schematic
- 13. Switch Panel Schematic
- 14. Distribution Harness
- 15. Adapter Harness
- 16. Fuel System Layout
- 17. Plumbing Diagram
- 18. Helm Area
- 19. UFLEX Steering System
- 20. Ignition Switches, Engine Shut-Off Cord/Lanyard
- 21. Plug and Play Wiring
- 21. Fuel-Water Separator - All Yamahas and Mercury Verado Only
- 22. Console / Head Area
- 23. VSR Battery System
- 24. Bilge Access and Explanation
- 25. Bilge Pumps
- 26. Raw Water Washdown System
- 27. Freshwater Washdown and Shower System
- 28. Livewell Operation
- 29. Trim Tab Maintenance
- 30. Optional Hard Top
- 31. Optional Lewmar V-700 Windlass
- 32. Lewmar V-700 Windlass Troubleshooting Chart
- 33. Optional Console Top Organizer
- 34. Optional Marine Head With Waste Tank (Type III MSD Waste Management System)
- 40. Optional Porta Potti
- 42. Vinyl Care and Cleaning
- 43. Aluminum Cosmetic Corrosion (Pitting)
- 44. Caring for Aluminum
- 45. Caring for Stainless Steel
- 46. Windshield, Window and Hatch Care Instructions
- 47. Gel Coat

Sailfish 242 CC Specifications



07/13/2020

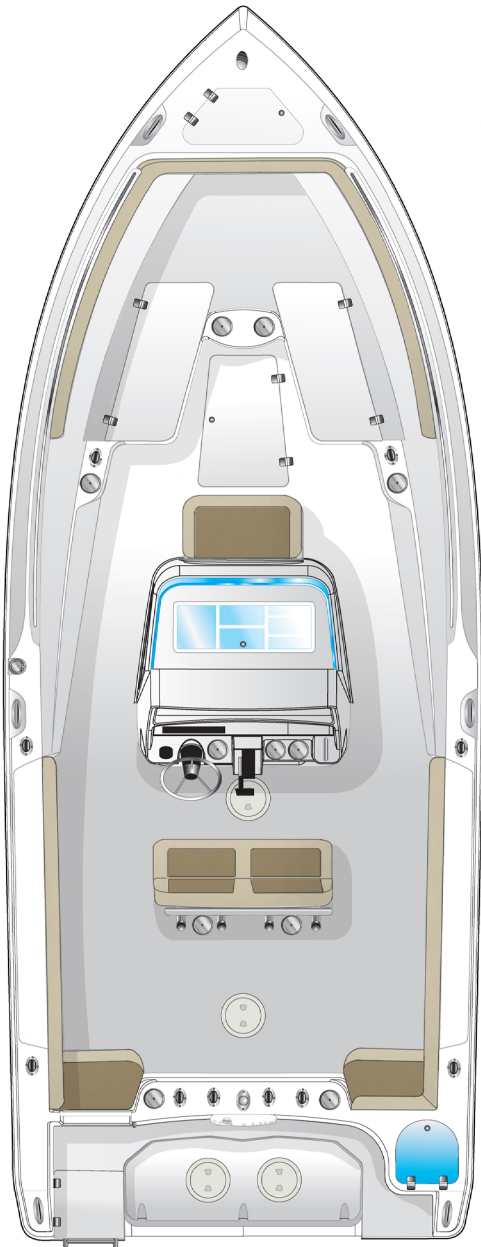

SPECIFICATIONS

LOA Hull Only	24'
Length Rigged	26'
Beam	9' 0"
Fuel Capacity	146 Gallons
Fresh Water	14 Gallons
Weight	5,600 lbs.
Cockpit Depth Rear	30"
Cockpit Depth Front	40"
Max Horsepower Single	300 hp
Draft (Hull Only)	18"
Dead Rise (Multiangle)	22°-24°
Battery Capacity	3
Rod Holders (Standard)	16
Bridge Clearance with Hard Top	8' 6"
Person Capacity	10

STANDARD FEATURES

Boat

- Boarding Ladder (4 step with grab handle)
- Built In Rigging Tubes (From Bilge to Helm with pull tapes)
- Carbon Fiber & Kevlar® Reinforced Deck & Hull
- Closed Cell Foam Flotation
- Cockpit Bolster Pads
- Cockpit Toe Rails
- Exclusive Dot Matrix Non-Skid Flooring
- Exclusive VDS Hull Design (Variable Deadrise Stepped Hull)
- Hydraulic Steering w/ Tilt SST Steering Wheel w/ Power Knob
- Mercury Verado Fuel Filter / Water Separator
- Oversized Bilge Access
- Powder Coat for OTP I (White)
- Recessed SST Cup Holders (11)
- SailTech Composite Full Length Transom System
- SailTech Foam Filled Fiberglass Stringer System
- SST Port Light (Head)
- Transom Mounted Tool & Raw Water Wash down Hose Holder
- Trim Tabs w/ Indicator & Built In Auto Retract Feature
- Two door access in console for wiring access
- Walk Thru Transom Door with Wave Guard Step
- Yamaha 10 Micron Fuel Filter / Water Separator w/ SST Base

Bow

- SST Split Low Profile Bow Rails

Electrical

- 12 Volt DC Accessory Plug
- Accessory Switch Panel w/Circuit Breakers
- Compass
- Electric Horn
- Full Digital Instrumentation
- Fully NEMA Compliant
- Fusion/Wet Sounds Stereo w/ USB Port
- LED Anchor Light
- LED Interior Cockpit & Bilge Lighting
- LED Navigational Flip Up Bow Light
- VSR Battery Charging System

Hardware

- Fender Cleats (4)
- Flush Mount Hinges, Latches & Deck Plates
- Heavy Duty SST Bow & Stern Eyes
- Heavy Duty SST Rub Rail
- Marine Grade SST Hardware
- Sailfish Engraved Transom Plate
- SST & Bronze Thru Hull Fittings
- SST Flush Mount Pull Up Cleats (6)
- SST Propeller(s)
- SST Rod Holders (6)
- Wind Screen w/ SST Grab Rail

Head

- Fresh Water Sink
- Head Compartment Lighting
- Lockable Head Door
- Mirror
- SeaDek® Flooring

Helm

- Large Dash Area (Capable of flush mounting 16" Screen)

Fishing

- Baitwell w/ LED Lighting (30 gal. Transom)
- Insulated Bow Fish Boxes (Twin 260 qt. w/ Overboard Drains)

Plumbing

- Automatic Bilge Pump (2000 GPH Aft and 750 GPH Forward)
- Freshwater Shower (2) - (Transom and Head)
- High Speed Live well Pickup
- Raw Water Washdown
- Self Bailing Cockpit
- Sink w/ Faucet (In Head)

Seating

- LP1 (Leaning Post w/ Flip-Up Bolsters)
- Forward Helm Seating

Storage

- Anchor Locker (Finished Fiberglass w/ Anchor Management System)
- Battery Storage (In Head)
- Deluxe Walk In Console (Lockable) w/ SST Port Light
- Footrest Console Storage
- In-Floor Storage (Bow w/ Bucket Holder)
- Recessed Rod Storage (Port & Starboard)
- Vanity Storage in Head

OPTIONS

Boat Options

- Bow Rod Holders (2)
- Bow Shade, Hard Top Only
- Captain's Anti-Fatigue Pad
- CL7 (C Series Motors Only)
- Console & Leaning Post Covers
- Console Top Tackle Organizer (CTO)
- Grand Slam Outriggers w/ 15' Poles
- Hard Top Enclosure (3 Piece)
- Hard Top w/ Radio Box & LED Lights
- Power Assist Steering
- Removable Bow Table
- Two Tone Hard Top
- Underwater LED Lights (3)
- VesselView 703
- Lewmar Bow Pre-Wire
- Windlass w/ Polished Roller, SST Scuff Plate, SST Anchor, Rode & Chain

Electrical Options

- Built-In 3 Bank Battery Charger w/ LED Readout
- Built-In Solar House Battery Charger (Hard Top Only)
- Fusion Transom Remote Control
- Garmin B60 Airmar Thru Hull Transducer w/o CHIRP
- Garmin B75M Airmar Thru Hull Transducer w/ CHIRP
- Garmin GPSMap 742xs w/o Transducer
- Garmin GPSMap 1042xsv w/o Transducer w/ Acrylic Panel
- Garmin 8612xsv GPSMap w/o Transducer with Acrylic Panel
- Garmin GPSMap Twin - (1) 8612xsv w/o Transducer, (1) 8612 with Acrylic Panel
- Garmin GMR™ 18 x HD Radome
- Garmin Radar Cable & Power Cable
- Garmin 215 VHF Radio & Antenna
- Remote Spot Light for Hard Top
- Wet Sounds LED Lighted Speakers Upgrade

Hardware Options

- Ski Tow Bar (Retractable)

Plumbing Options

- Electric Marine Head w/Holding Tank, (with deck pump out fitting)
- Misting System (For Hard Top only)
- Motor Flushing System (Twins Only)
- Overboard Discharge Upgrade
- Porta Potti
- Porta Potti (Pump Out)

Seating Options

- Bow Filler Cushion
- LP4 (White Fiberglass LP w/ cooler & Backrest)
- LP13 (Double Mini Billfish Seats w/ flip up Bolsters & Arm Rests w/Tackle Storage)

Optional Packages

- **Comfort Package**
Rear Jump Seats, Bow Cushion Bottoms, Bow Bolsters, FF Bow Backrests
- **Entertainment Package**
Ski Tow Bar, Removable Bow Table, Fusion Transom Remote Control & Underwater LED Lights (3)
- **Offshore Tournament Pack I**
Hard Top P.C. w/PFD Storage, Transom Rod Holders & Netting Package
- **Powder Coat for O.T.P. I (Black)**

Engine Options

Yamaha

- F300UCA
- Twin F115XB
- Twin F150XB
- Twin F150XCA
- White Painted Motor (n/a on twin 115 or 150's)

Mercury

- Twin 150XL
- 300XXL Verado
- White Painted Motor (n/a on twin 150's)

SAILFISH BOAT TRAILER MEASUREMENT CHART:

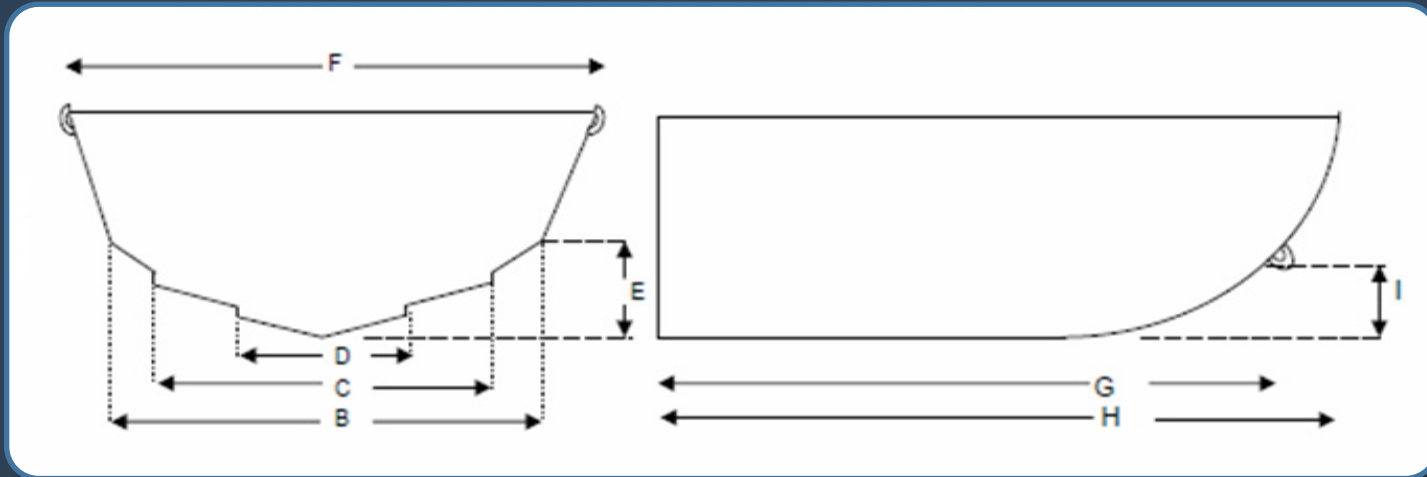

Boat Models	B	C	D	E	F	G	H	I
208CC	78 in.	53 in.	28 in.	11 in.	82 in.	218 in.	235 in.	27 in.
1900BB	88 in.	66 in.	37 in.	10.5 in.	99.5 in.	198 in.	217 in.	24 in.
2100BB	88 in.	66 in.	37 in.	10.5 in.	99.5 in.	220 in.	240 in.	24 in.
220CC & 220WAC	87 in.	59 in.	31 in.	14.5 in.	102.5 in.	216.5 in.	243 in.	32 in.
236CC & 241CC & 245DC	91 in.	57.5 in.	30 in.	14 in.	103 in.	250 in.	273 in.	36 in.
240CC & 240WAC & 242CC	92 in.	59 in.	31 in.	15 in.	107 in.	241 in.	272 in.	30 in.
270CC & 270WAC	94 in.	59 in.	31 in.	15 in.	107 in.	268 in.	302 in.	30 in.
272CC & 276DC	93 in.	61 in.	32 in.	15 in.	109 in.	287 in.	321.5 in.	38 in.
275DC	94 in.	59 in.	31 in.	15 in.	107 in.	268 in.	302 in.	30 in.
290CC	94.5 in.	61 in.	32 in.	15.5 in.	107 in.	301 in.	336 in.	30 in.
320CC & 320EXP & 325DC	105 in.	65 in.	33 in.	16.5 in.	115 in.	315 in.	349 in.	38 in.
360CC	119 in.	72 in.	36 in.	20.1 in.	135 in.	383.34 in.	417.5 in.	48.19 in.

Sailfish 242 CC Boat Layout



07/13/2020

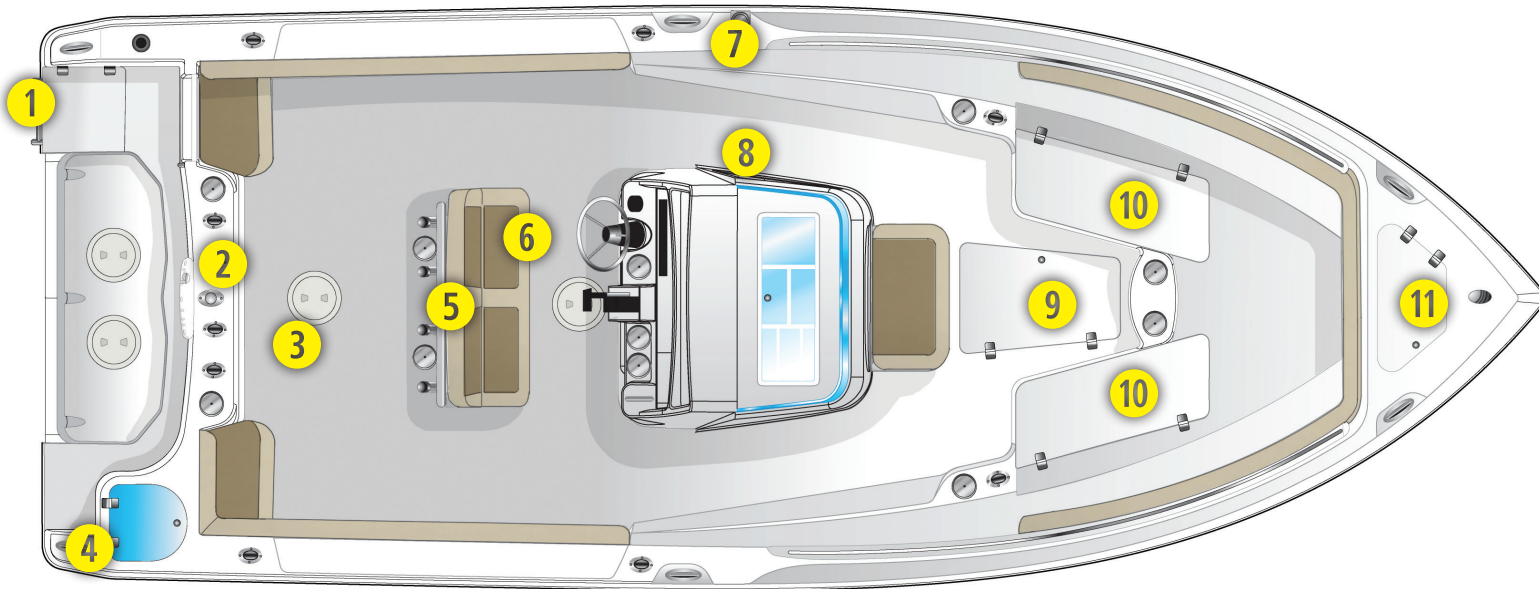

Key	Description
1	Boarding Ladder / Fresh Water Fill
2	Bilge Access
3	Fuel Sender and Pick-Up Access
4	30 Gallon Livewell
5	Optional Leaning Post
6	Helm Area

Key	Description
7	Fuel Fill
8	Console and Head Area
9	Floor Storage
10	Insulated Fish Boxes (Boxes drain overboard)
11	Anchor Locker

Sailfish 242 CC Seating Locations



07/13/2020

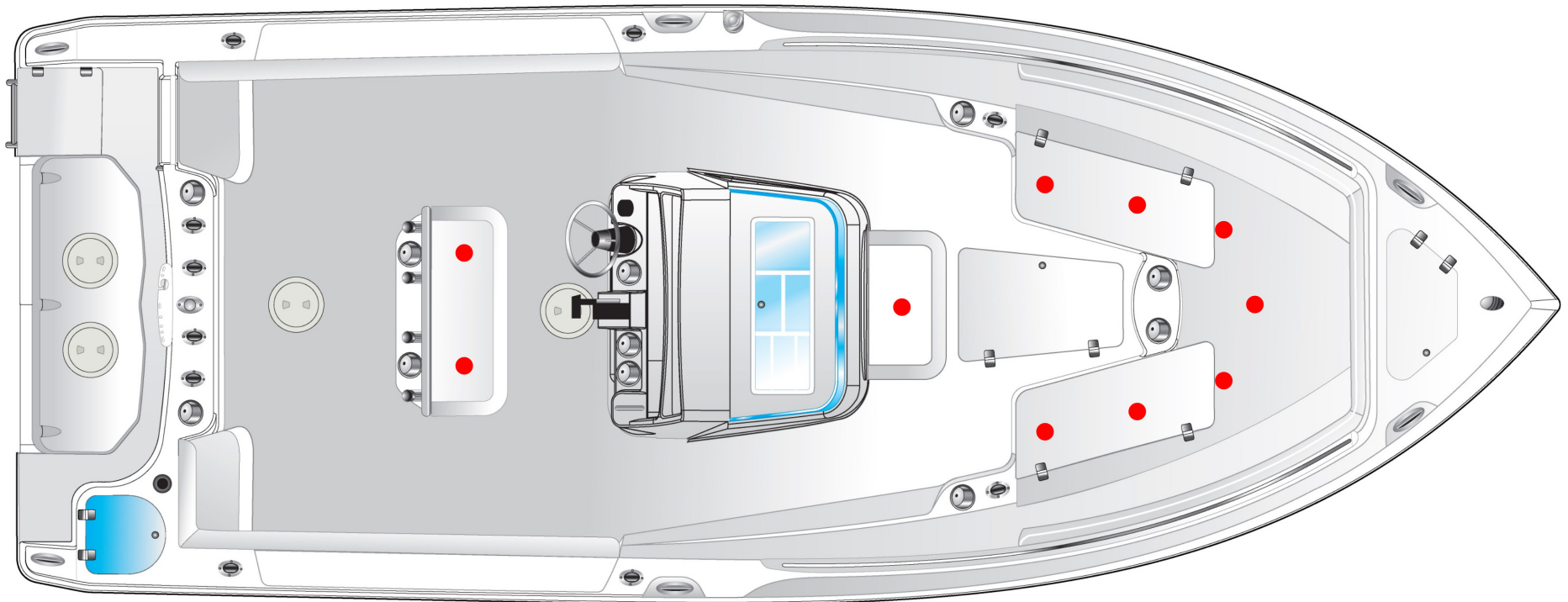

Boat Safety & Warning Labels



07/13/2020

Warning Labels

The safety for you and everyone on board, as a boat owner, you need to become familiar with and the locations of the Caution, Warning and Danger Labels found on your boat.

Below are images of the labels to help you maintain and operate your boat safely.

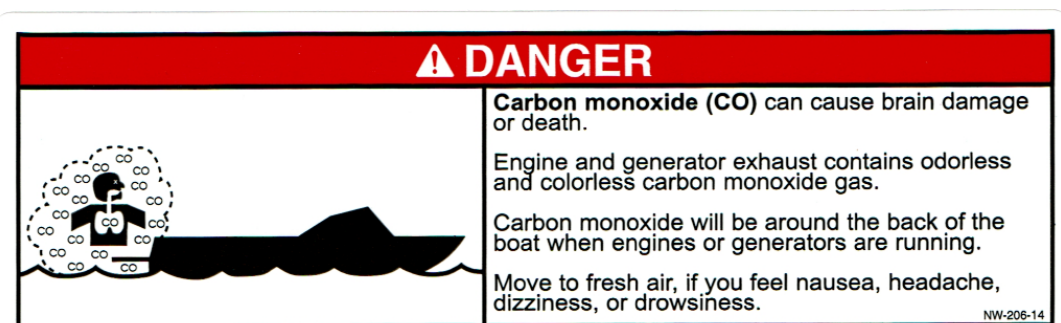
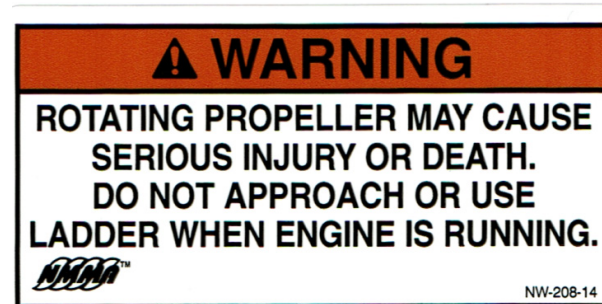
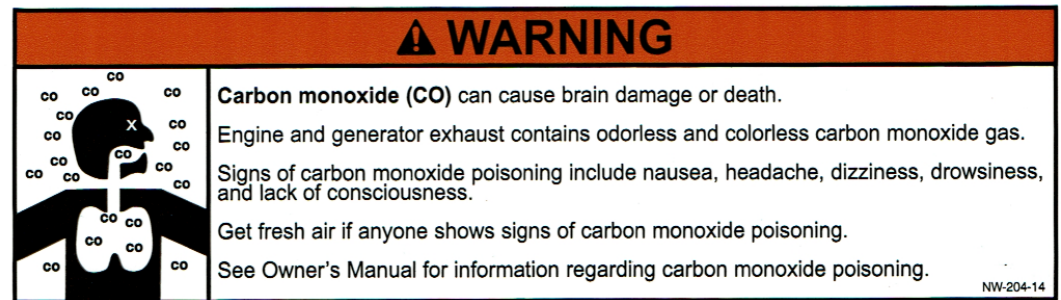
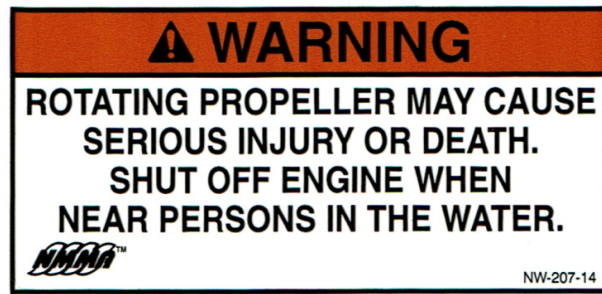

Boat Safety & Warning Labels



07/13/2020

Warning Labels Continued

The safety for you and everyone on board, as a boat owner, you need to become familiar with and the locations of the Caution, Warning and Danger Labels found on your boat.

Below are images of the labels to help you maintain and operate your boat safely.



Boat Safety & Warning Label Locations



07/13/2020

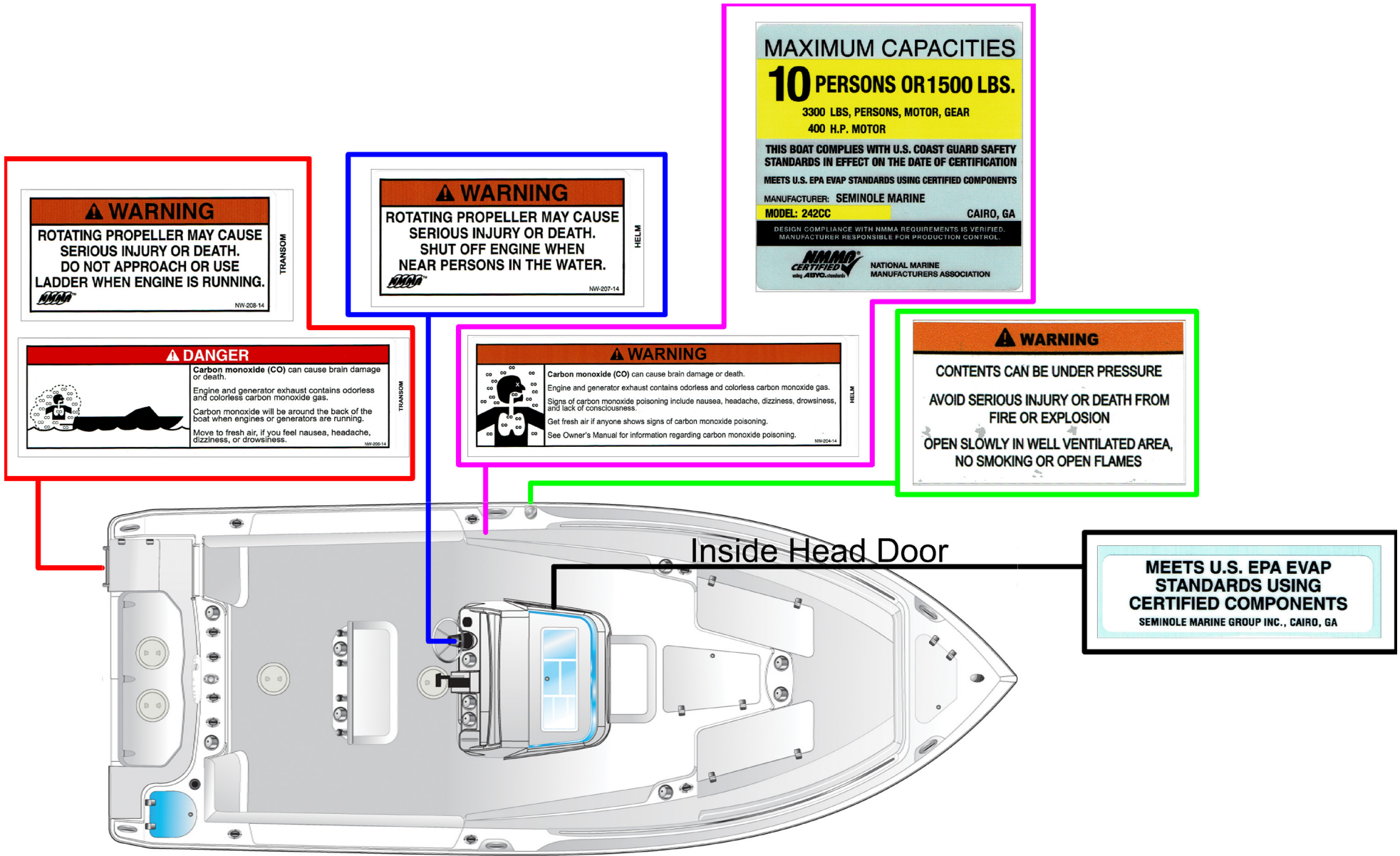

⚠ WARNING
 ROTATING PROPELLER MAY CAUSE
 SERIOUS INJURY OR DEATH.
 DO NOT APPROACH OR USE
 LADDER WHEN ENGINE IS RUNNING.

⚠ WARNING
 ROTATING PROPELLER MAY CAUSE
 SERIOUS INJURY OR DEATH.
 SHUT OFF ENGINE WHEN
 NEAR PERSONS IN THE WATER.

MAXIMUM CAPACITIES
10 PERSONS OR 1500 LBS.
 3300 LBS. PERSONS, MOTOR, GEAR
 400 H.P. MOTOR
 THIS BOAT COMPLIES WITH U.S. COAST GUARD SAFETY
 STANDARDS IN EFFECT ON THE DATE OF CERTIFICATION
 MEETS U.S. EPA EVAP STANDARDS USING CERTIFIED COMPONENTS
 MANUFACTURER: SEMINOLE MARINE
 MODEL: 242CC CAIRO, GA
 DESIGN COMPLIANCE WITH NMMA REQUIREMENTS IS VERIFIED.
 MANUFACTURER RESPONSIBLE FOR PRODUCTION CONTROL.

⚠ DANGER
 Carbon monoxide (CO) can cause brain damage
 or death.
 Engine and generator exhaust contains odorless
 and colorless carbon monoxide gas.
 Carbon monoxide will be around the back of the
 boat when engines or generators are running.
 Move to fresh air, if you feel nausea, headache,
 dizziness, or drowsiness.

⚠ WARNING
 Carbon monoxide (CO) can cause brain damage or death.
 Engine and generator exhaust contains odorless and colorless carbon monoxide gas.
 Signs of carbon monoxide poisoning include nausea, headache, dizziness, drowsiness,
 and lack of consciousness.
 Get fresh air if anyone shows signs of carbon monoxide poisoning.
 See Owner's Manual for information regarding carbon monoxide poisoning.

⚠ WARNING
 CONTENTS CAN BE UNDER PRESSURE
 AVOID SERIOUS INJURY OR DEATH FROM
 FIRE OR EXPLOSION
 OPEN SLOWLY IN WELL VENTILATED AREA,
 NO SMOKING OR OPEN FLAMES

**MEETS U.S. EPA EVAP
 STANDARDS USING
 CERTIFIED COMPONENTS**
 SEMINOLE MARINE GROUP INC., CAIRO, GA

Inside Head Door



Replacement Warning Labels

If any of your Boating Safety or Warning Labels become damaged, please call Sailfish Boats' parts department for replacement stickers at 229-377-2125



SAILFISH

FISHING FOCUSED. FAMILY FRIENDLY.™

Boarding Ladder & Unassisted Boarding Situations



07/13/2020

Unassisted Boarding Instruction

When using the ladder in an unassisted boarding situation, reach over the transom and open the covering board lid that is covering the ladder, pull ladder towards you, by picking up the ladder by the steps, release the strap, deploy the four step ladder by rotating it to the down position. Use your hand or foot to fully extend the ladder in the down position. Use the grab handle and ladder to board your boat. When fully onboard, be sure to place the ladder back in the storage position by reversing the deployment process.

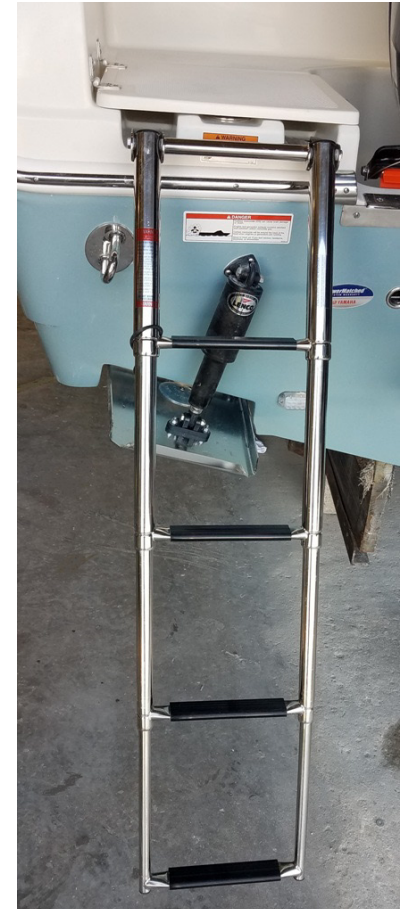



Front View

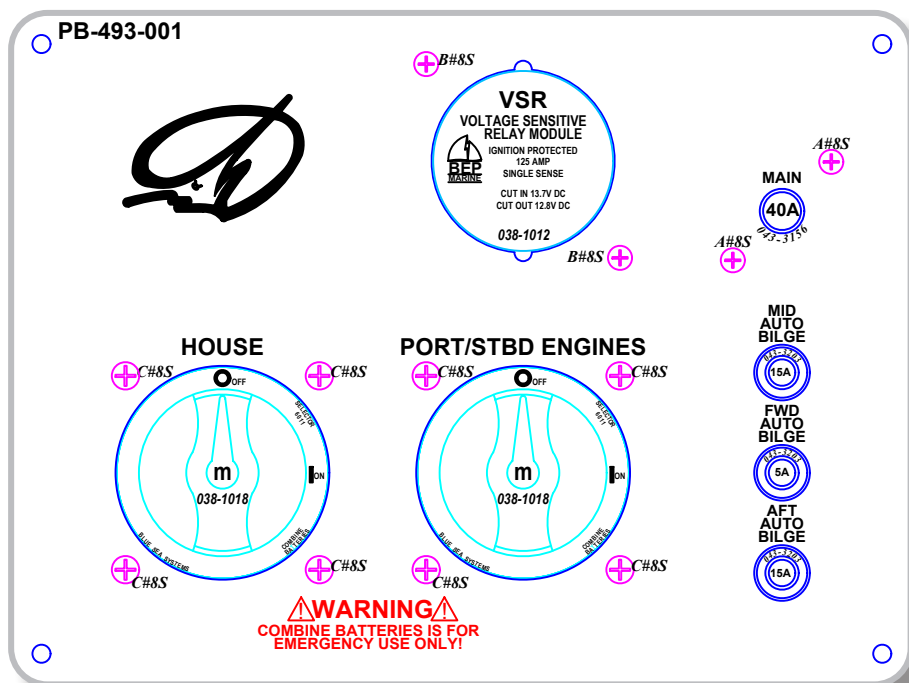

Back View With Wiring

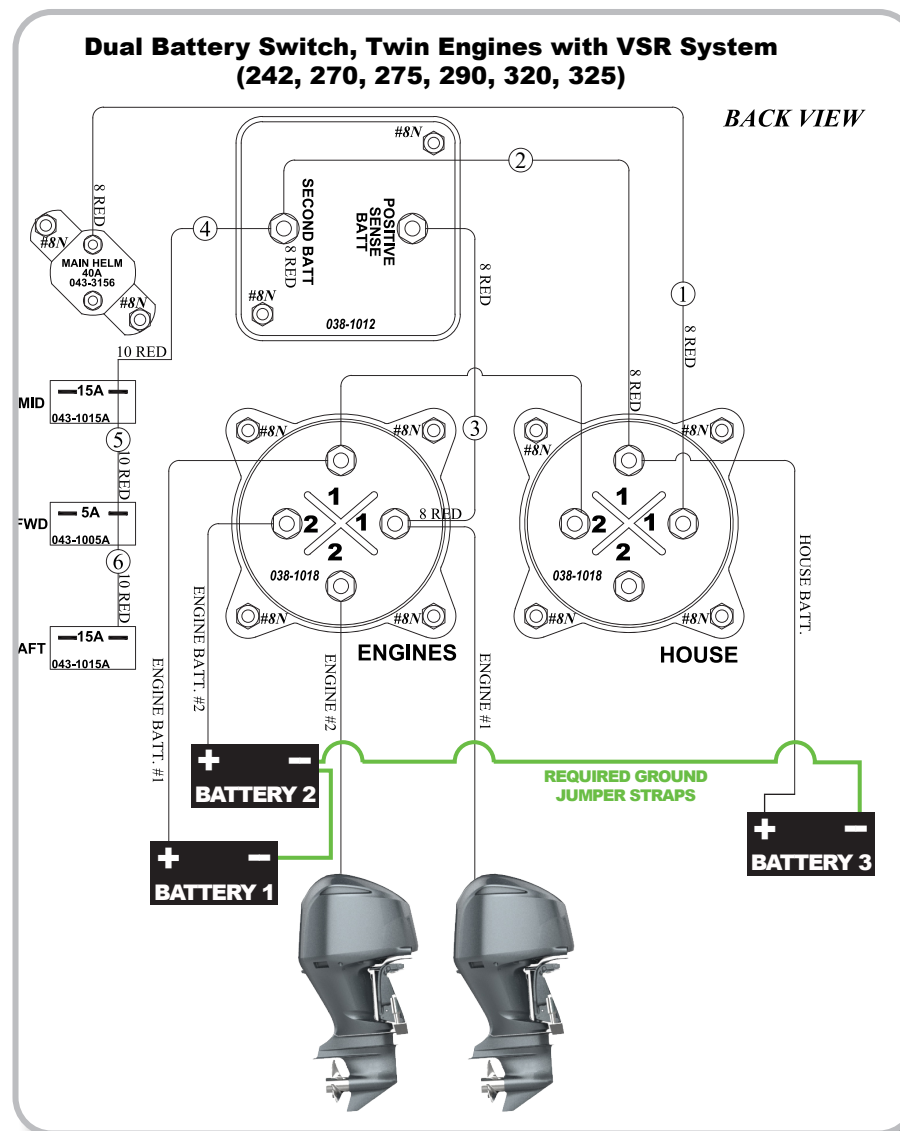

Breaker Panel Schematic



07/13/2020

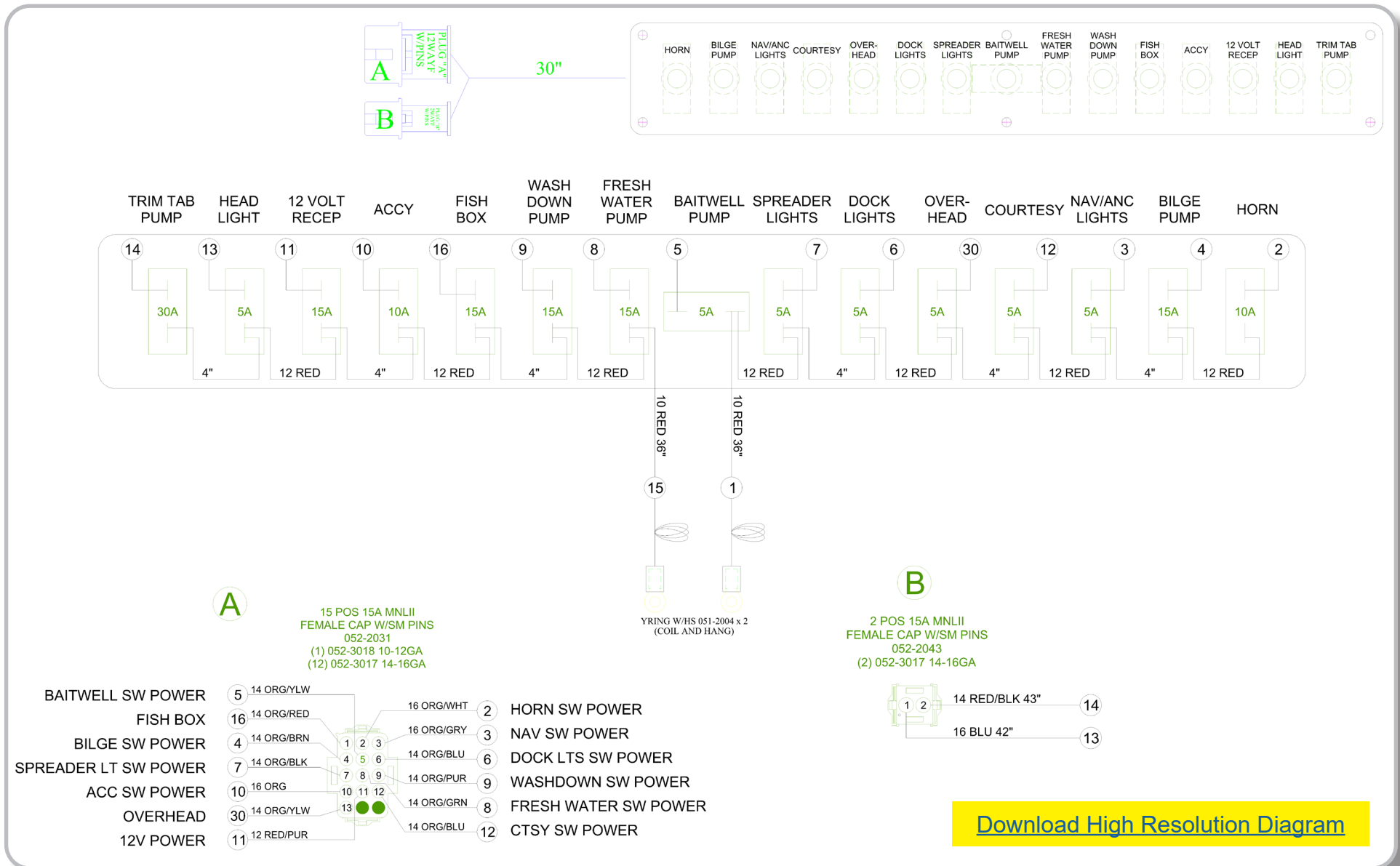

Distribution Harness



07/13/2020

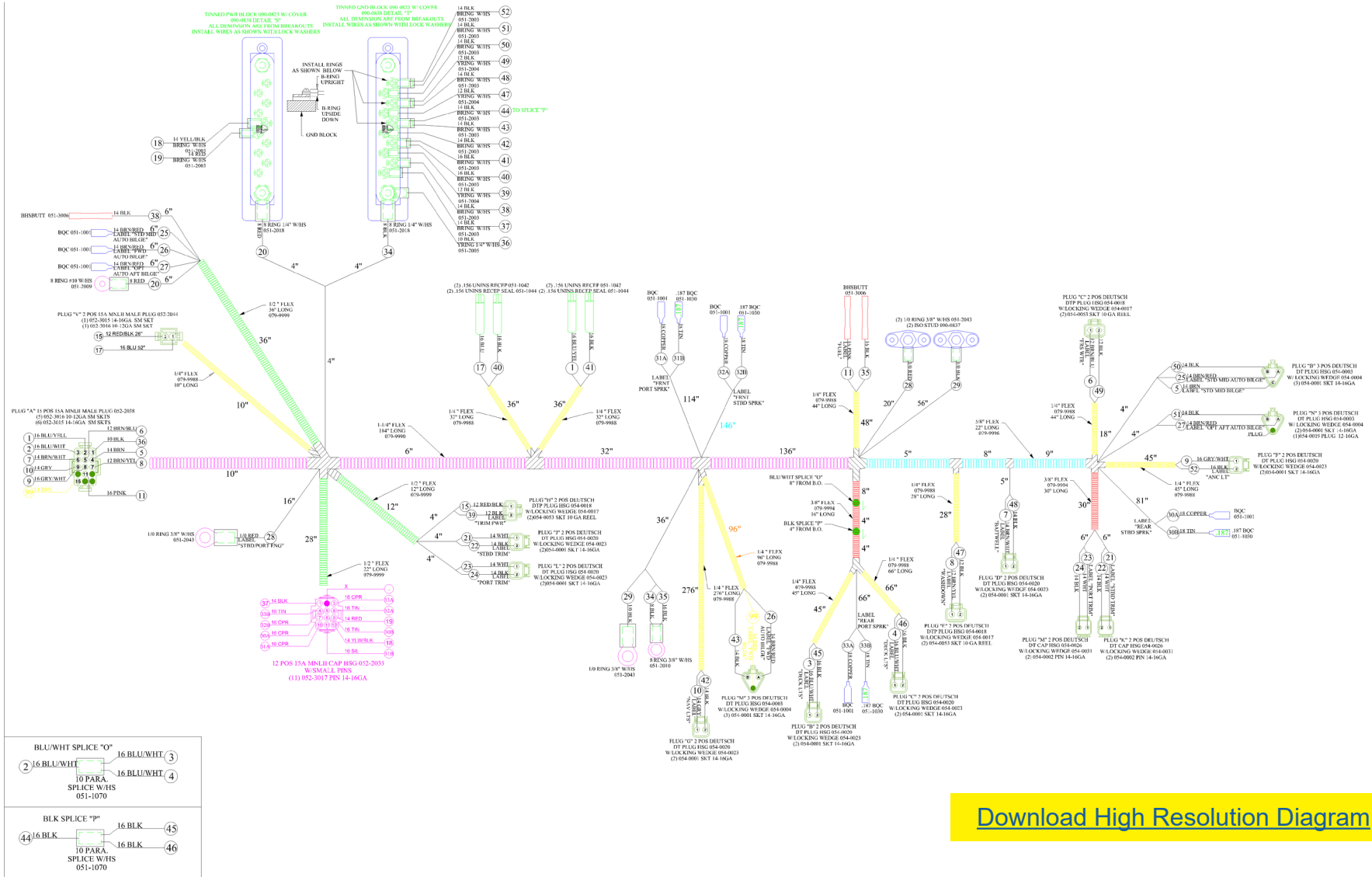

Adapter Harness



07/13/2020

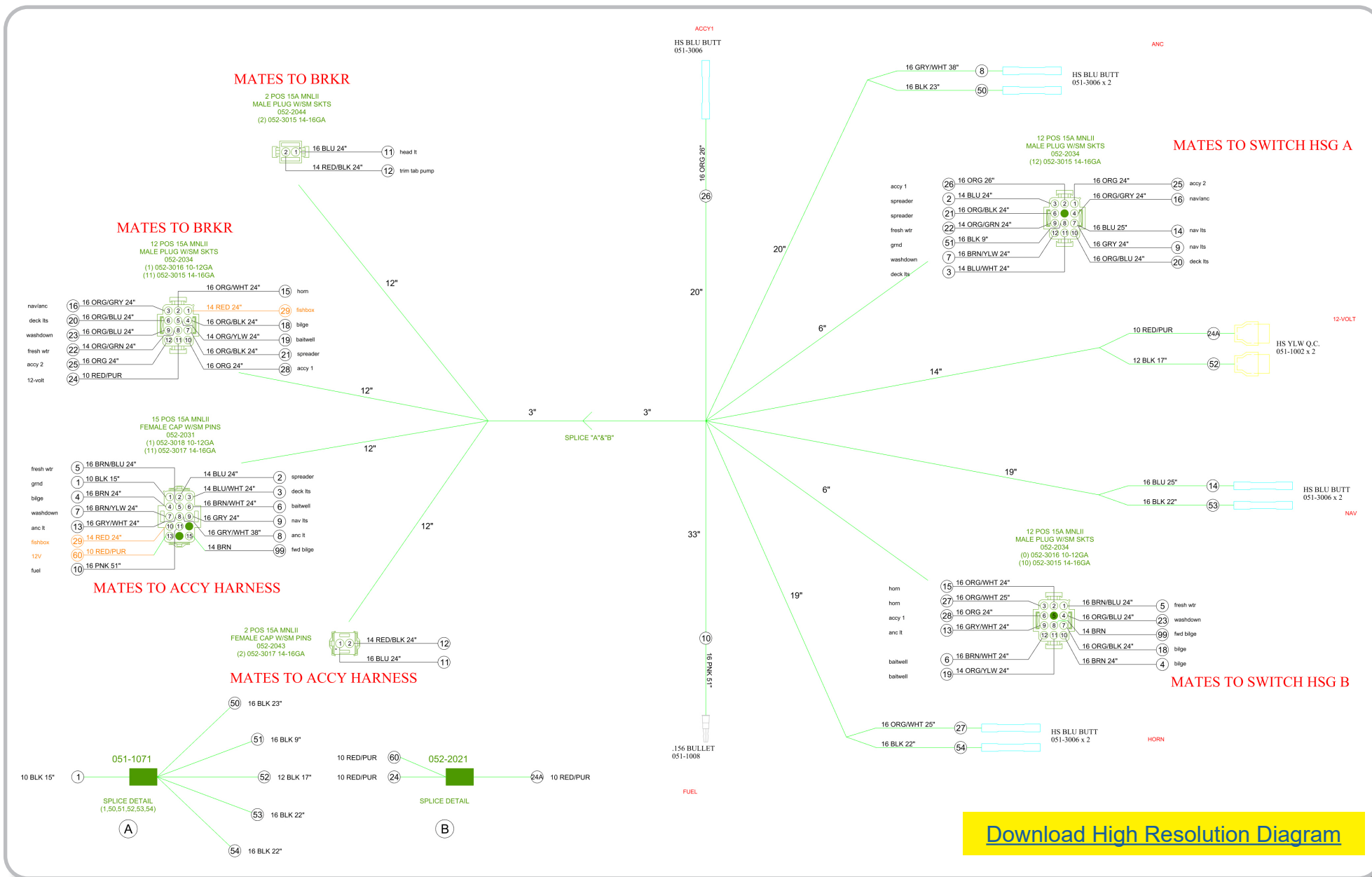

[Download High Resolution Diagram](#)

Fuel System Layout



07/13/2020

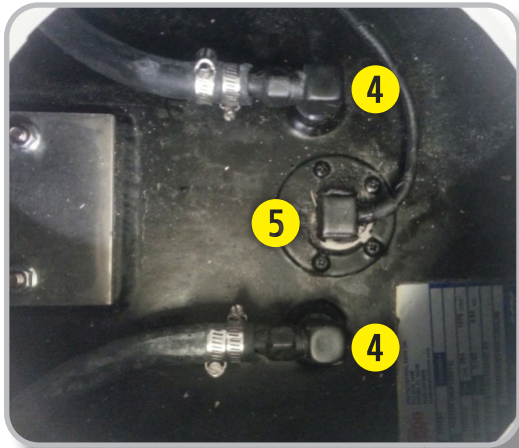

Key	Description
1	Fuel Filter Access - All Yamaha and Mercury (Verado Only)
2	Fuel Fill
3	Fuel Tank Location
4	Fuel Pickups
5	Fuel Sender
6	Primer Bulbs - All Yamahas and Mercury 150HP Only

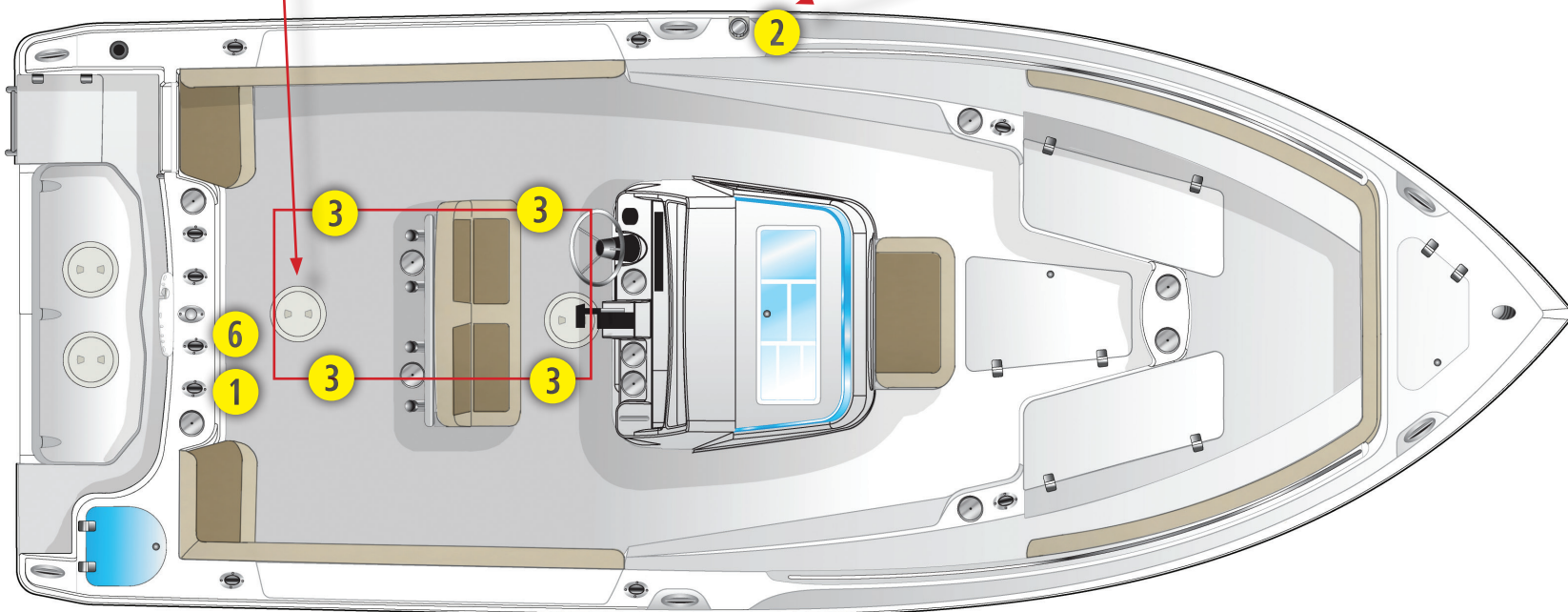

Plumbing Diagram



07/13/2020

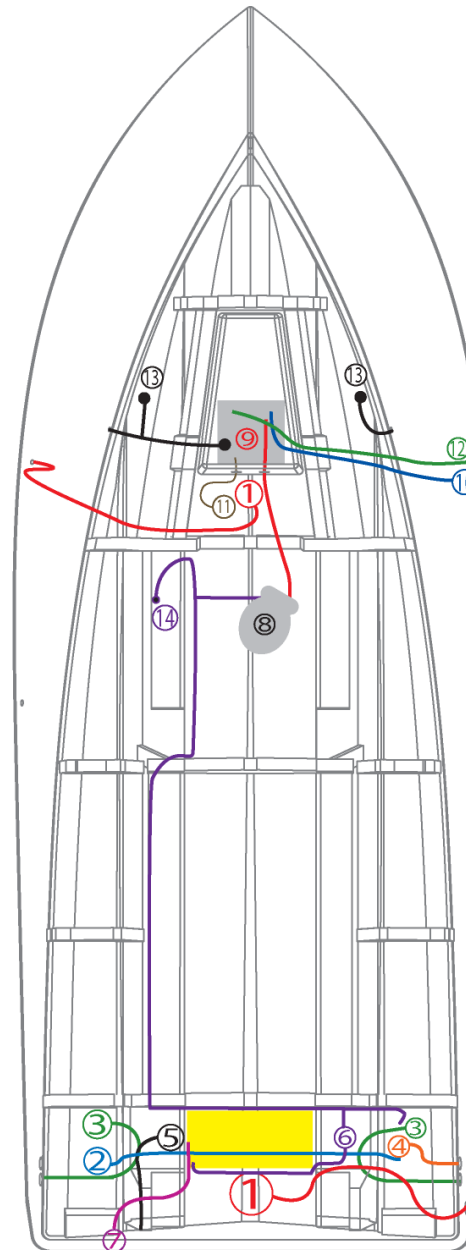

- 1. Bilge Pump
- 2. Livewell Fill Pump
- 3. Deck Drain
- 4. Livewell Drain
- 5. Transom Washdown Pump
- 6. Fresh Water Pump
- 7. Fresh Water Fill and Vent
- 8. Fresh Water Toilet (opt)
- 9. Waste Water Tank
- 10. Dockside Pump Out
- 11. Waste Water Discharge
- 12. Head Vent
- 13. Fish Box Drains
- 14. Fresh Water Sink

Helm Area



07/13/2020

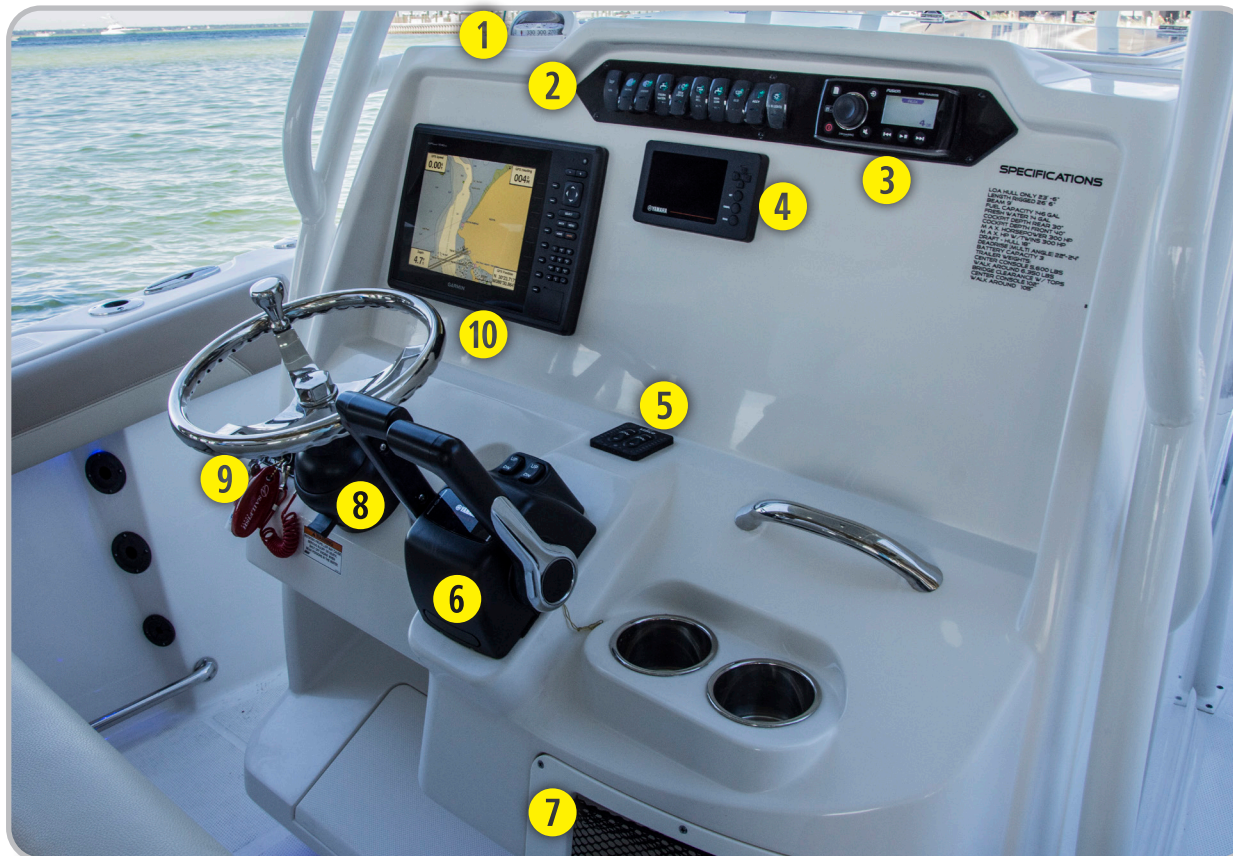

Key	Description
1	Compass
2	Switch Panel
3	Optional Stereo
4	Brand Specific Motor Gauges
5	Trim Tab Actuator Switches
6	Binnacle (Shown with Twin Engines)
7	12 Volt Receptacle Inside Storage Pocket
8	Uflex Tilt Helm
9	Ignition Switches
10	Optional Garmin Electronics



UFLEX Steering System

UFLEX has been the choice for steering for Sailfish boats for the last three years because of the quality of the USA built products.

Every helm comes standard with a full stainless steel shaft; cylinders are built with carbon steel pistons, coupled with extra-large end caps to prevent leakage.

All of their connection materials are 304 stainless steel that has been electro-polished and passivated.

For more information on the service and maintenance of your UFLEX system please refer to your UFLEX owner's manual or view it electronically at http://uflexusa.ultraflexgroup.com/public/File/UFLEX2013_USA.pdf

Ignition Switches, Engine Shut-off Cord/Lanyard

Each Sailfish boat will be equipped with a Yamaha or Mercury ignition switch with an emergency engine shut off cord/lanyard.

This lanyard should be worn at all times while operating the vessel, if the vessel operator falls or moves a unsafe distance away from the helm controls the lanyard will pull out causing the engine to shut down.

Make sure the lanyard is not attached to a part of your clothing that could be easily torn free causing the switch not to pull. See your YAMAHA or MERCURY owner's manual for more information on this safety feature.

Engine Break-In Period

Each new outboard motor will need to go through a break in period to make sure all of the internal moving parts and components have a chance to correctly mate.

For more information on the break in period specific to your engine please refer to your YAMAHA or MERCURY Owner's manual.

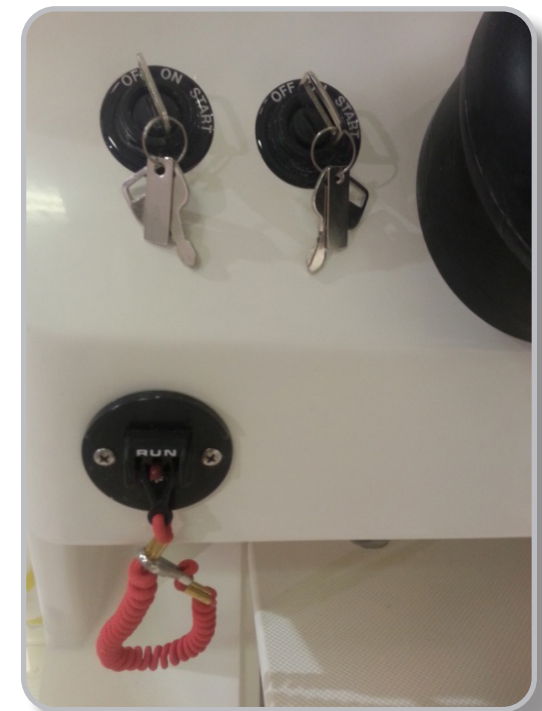

Plug and Play Wiring

Deutsch Connectors are quick disconnect plugs used for durability and ease of replacing components in your Sailfish Boat.

These water resistant plugs are for use in electrical systems where moisture, salt spray, dirt and dust could affect the electrical connections or systems.



Fuel-Water Separator

Sailfish has rigged either Yamaha or Mercury, (Verado Only), water fuel separators in the bilge compartment. Each engine will have its own filter. These filters can be accessed through the bilge access doors, in the back of the boat. For more information on these filters, please review your Yamaha or Mercury Owner's Manuals.

Console/Head Area



07/13/2020

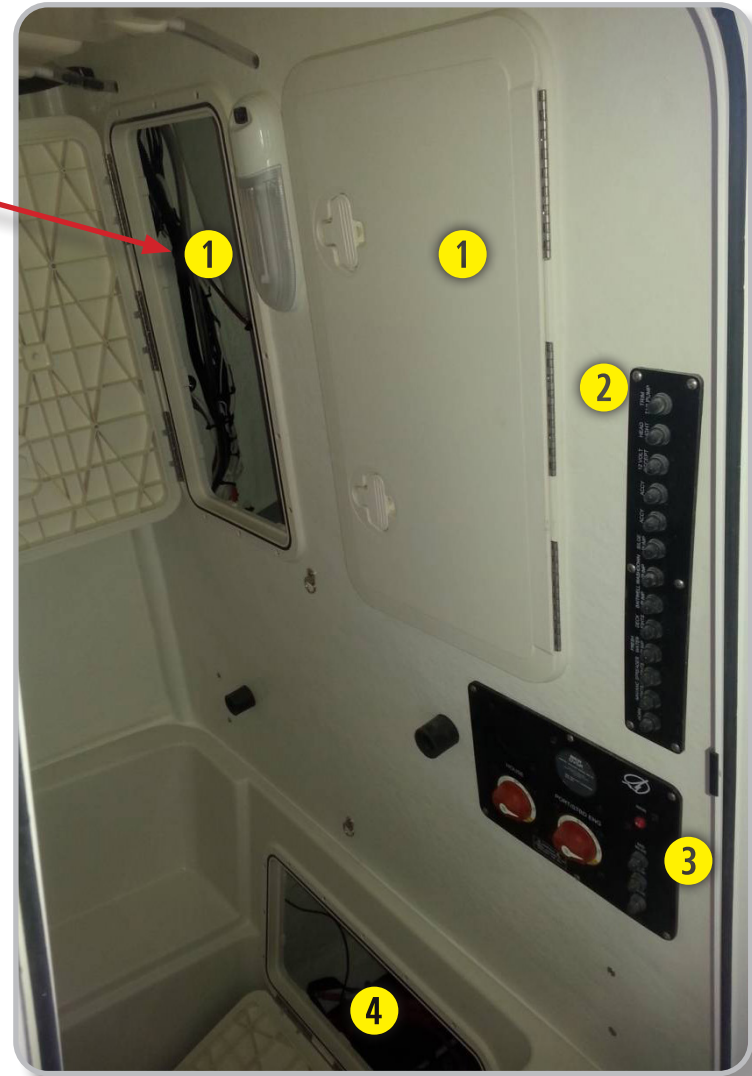

Key	Description
1	Large panel for easy access to Console Components
2	Breaker Panel
3	Battery Selector Panel
4	Battery Storage and Access Hatch

VSR Battery System

- “The Smart Battery Switch”



07/13/2020

The VSR, or Voltage Sensitive Relay, is a very handy little box that solves a load of traditional charging problems on marine electrical systems. It essentially serves as a smart battery switch deciding automatically when either one or two batteries are charged – or discharged. It works great on almost any boat with multiple batteries – and eliminates all of the guesswork that used to come with manual battery switches.

What a VSR does

The VSR is installed between two batteries. Many People are surprised to learn that it is NOT connected to either the alternator or charger output wires! Its setup is much more clever.

If either battery goes above 13.7 volts (due to either alternator or charger output), the VSR connects both batteries together. Both batteries are now charging – without the boat ever having to throw a switch.

Alternately, when the system voltage drops back below 12.6 volts, i.e., no more charging, the relay opens and the batteries are separate. This means that both batteries now discharge independently.

How a VSR changes real world boating

Let's say that a fishing boat has a two battery setup. As is often the case, one of the batteries is dedicated to an important job – starting the engine. The other battery is used for other operations.

As the fisherman runs the boat from hole to hole, the engine alternator elevates the voltage to the cranking battery above 13.7 volts. This triggers the VSR to automatically connect the starting

battery and house battery together. Both are now charging. Upon reaching his destination, the boater kills the engine – and, the alternator output – and begins trolling. Because of the lowered voltage, the VSR now disconnects the batteries. Because he is now discharging only one battery, our fisherman is going to have starting power when he needs it later – no matter how long he uses the trolling motor and depletes that trolling battery. Once underway again, the alternator power causes the VSR to reconnect the batteries and begins replenishing the trolling battery.

Back home, the fisherman powers up his onboard battery charger, this increased voltage causes the VSR to once again link the batteries. This means that even a single output battery charger would now be charging both batteries!



Bilge Access and Explanation

The bilge of your boat can be accessed through the large door in the aft of the boat. This large door allows easy access too many of the boats components.

You may also access it through the two access plates in the splash-well.



The bilge area of your sailfish boat should be checked before, during and after each operation.

Bilge Pumps

All Sailfish Boats are furnished with Rule Bilge Pumps, The Rule 2000 GPH (gallon per hour) pump has a built in automatic float switch. This is engaged when the water level rises in the bilge and the float rises in the pump causing the pump to turn on.

These pumps can be tested by turning them upside down, the pump should turn on, once turned back over it will run for a few more seconds and then shut off. The pumps also have a manual switch function on the main switch panel.

These pumps are wired into your boat bypassing the battery switch so that they have power at all times, this allows the automatic feature to work while you are away from the boat and the batteries are turned off.

Sailfish boats 241CC and larger are equipped with a forward bilge pump that is an electronic sensor pump. These pumps have a state of the art internal water sensor that detects water and automatically activates the pump when there is enough present to be pumped out.

These pumps can be tested by placing your finger over the "Test Area" on the back of the pump for 5 seconds, the pump will turn on to let you know it is functioning correctly. All wiring and switches to these pumps are the same as the Rule 2000GPH pumps.



Raw water Washdown system

The raw water wash down on your Sailfish Boat is powered by a Shur-flo Pro Blaster Pump which creates a pressurized system, once the pump is turned on and pressure is created the pump will shut down until more pressure is needed. The raw water wash down pump can be accessed through the bilge access door in the aft of the boat.

To operate make sure the seacock is in the open position. The hose fitting for the wash down is located in the transom splash well, to use simply attach a hose with a nozzle and turn the switch on. Pressure will build up in the hose and the nozzle and as you spray the pump will continue to engage as needed.



Freshwater Washdown and Shower System

The freshwater washdown and shower system on your Sailfish Boat is powered by a Shur-flo Pro Blaster Pump which creates a pressurized system, once the pump is turned on and pressure is created throughout the freshwater hoses; once they are all pressurized the pump will shut down until more pressure is needed.

All of the freshwater systems on the boat will operate on this system once the freshwater switch is engaged.

You should allow a few seconds for the system to prime and pressurize before attempting to use any of the showers/sinks ect.

The freshwater holding tank is located behind the fuel tank in the bilge area.

The fill for this tank is located under the boarding ladder on the port side of the vessel. The freshwater pump can be accessed through the bilge access door in the aft of the vessel.



Instructions

- Make sure the seacock below the baitwell pump is in the open position (seacock is accessed through the hatch under the transom walk thru door).
- Turn on the livewell switch.
- Adjust the black aerator in the livewell to the desired flow (if your model has a livewell in the leaning post you can adjust the aerator to pump water into the transom livewell or the leaning post livewell or both)
- In order to fill the livewell, reach in the access hatch below the livewell and close the red handle ball valve.
- The livewell will fill up until it reaches the Overflow built into the side of the livewell. This allows the water to continually pump in and drain out while maintaining the water level.
- To drain the livewell open the red handle ball valve.

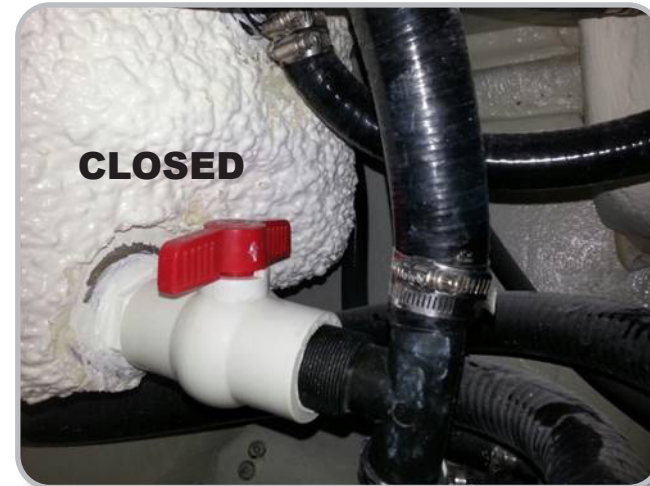

Cleaning

The attractive surface appearance of stainless steel cannot be regarded as completely maintenance-free. Our 304 Series Stainless Steel may in fact stain, discolor, or accumulate a layer of surface contamination (dirt and grime) during the normal course of the life cycle.

Minute particles of dust and rust may adhere to the stainless steel during shipping, installation or storage at OEM or retail locations.

Also, please remember that some types of stainless steel fasteners tend to “bleed” over the tabs and onto the boat. To achieve maximum corrosion resistance, the surface of the stainless steel must be kept clean and free of all these contaminants.

NOTE: Lenco RECOMMENDS AN ACID AND WATER SOLUTION TO CLEAN THE TRIM TAB BLADES. MARYKATE’S ON & OFF PRODUCT IS A GOOD CHOICE. RINSE THOROUGHLY UPON COMPLETION. BIODEGRADABLE, BUT PLEASE FOLLOW THE MANUFACTURER’S INSTRUCTIONS BEFORE APPLYING.

Sacrificial Anodes for your Lenco SS Trim Tabs

Be aware that stray currents in your marina or in a visiting marina can cause damage to your trim tab blades if not protected by sacrificial anodes.

- The addition of anodes on each tab will deter electrolysis.
- Do not paint under the anode or the anode itself.
- Check Anode condition frequently. Replace when necessary.

Visual inspection of system

- Periodically inspect all wires, mounting brackets, and hardware for damage.
- Make sure all mounting brackets are secure and working properly.
- Periodically test system for smooth operation.



Optional Hard Top



07/13/2020

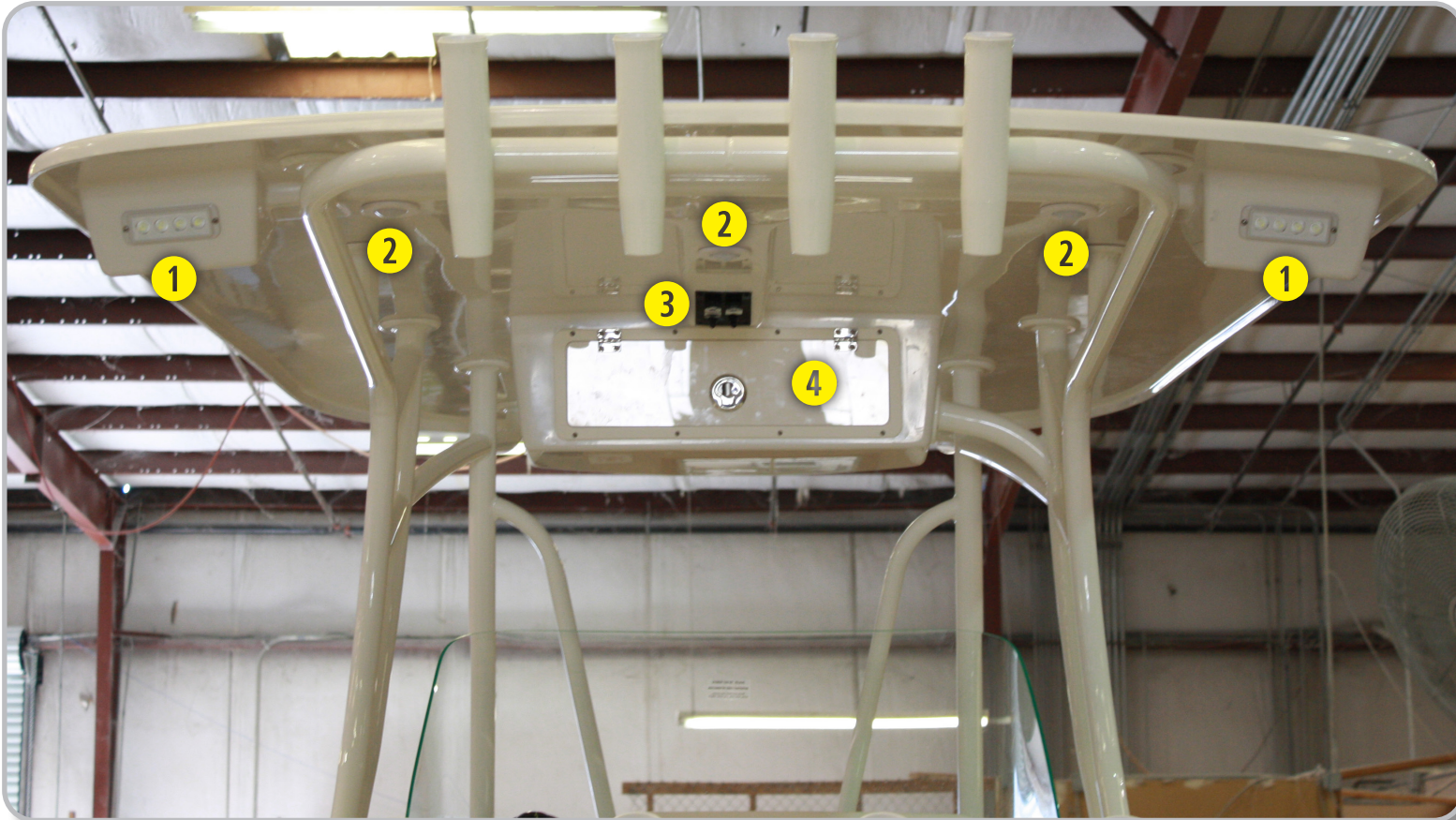

Key	Description
1	Spreader Lights
2	Courtesy Lights
3	Switch Panel
4	Storage Box/E-Box



If your boat has a factory installed windlass there will be a complete owners' manual in your owners packet. For more detailed information please refer to your windlass owners manual. If you have a thru hull windlass system the remote will be stored forward in the windlass hatch.

Included on this page are some maintenance recommendations and a troubleshooting guide.

Maintenance

General Recommendations

- After the first two or three anchor recoveries, check the mounting nuts to ensure that the windlass is still fastened tightly to your deck, as it should now be bedded-in.
- Regularly wash down the exterior of your windlass with fresh water.
- Examine all electrical connections for possible corrosion, clean and lightly grease as necessary.
- Anchor rode splice should be checked regularly and remade if there is any evidence of wear.
- The Gypsy should be examined on a regular basis, because it is a high wear item. The Gypsy is designed for short scopes of chain and will last longer if properly used.



The windlass breaker is located in the head/console compartment.

Troubleshooting

Anchor Rode pays out independently while windlass is not in use

This problem is a result of not securing the anchor rode combined with the Gypsy Drive Cap being slack. Tighten the Gypsy Drive Cap using the tool provided and always secure the anchor rode independently of the windlass whenever it is not being deployed or recovered.

Electrical Troubleshooting

As with most electrical marine equipment the majority of problems that arise are electrical in nature. Therefore it is essential that the proper voltage be maintained. The proper voltage on a 12 Volt system is 13.5 Volts. (Constant low voltage will destroy the motor). Ensure that electrical cable size is large enough to handle the current draw imposed upon it and keep the voltage drop within acceptable limits. In any circumstance voltage drop due entirely to cable resistance should not exceed 10%.

Follow the charts on the following page to troubleshoot the problem.

Sailfish 242 CC - Windlass Troubleshooting Chart



07/13/2020

Failure to Operate Troubleshoot Chart: Reversing Toggle Control Switch (Part No. 0052519)	
Is there voltage at the input terminal (positive) to the control switch?	If no voltage is present, the battery isolation is OFF, the breaker is tripped or a fuse has blown. The battery may also have been dead or disconnected.
Yes ▼ No ►	
Check voltage at the output terminals of the control switch with the switch on forward then reverse.	Control switch is defective.
Yes ▼ No ►	
Replace Motor	
Sluggish Operation Troubleshoot Chart	
Is windlass overloaded?	Ease the load and ensure the battery is well charged.
Yes ▼ No ►	
Check the voltage across the motor leads with the windlass on. (Proper voltage is 13.5V. Constant low voltage will destroy the motor). Is the voltage low? (Below 11.0V on a 12V system?)	There is a severe voltage drop in the circuit. Check for undersized cables, poor connections or corroded connections. Also check for resistance across the battery isolation switch or solenoid. (Feel them to see if they are heating up).
Yes ▼ No ►	
Is the voltage correct? (Above 11.0V and anchor is not fouled).	The motor is defective. Replace the motor.
Yes ▼ No ►	

Optional Console Top Organizer



07/13/2020

Console Top Organizer

Standard on the 290CC and 320CC the console top organizer is a great place to store almost anything. It also includes a 12 Volt plug, MP3/USB hook up, and a headphone jack for playing music from a phone or I-pod.

Always store the organizer with the lid closed and the spring positioned as it is in the picture to the right.

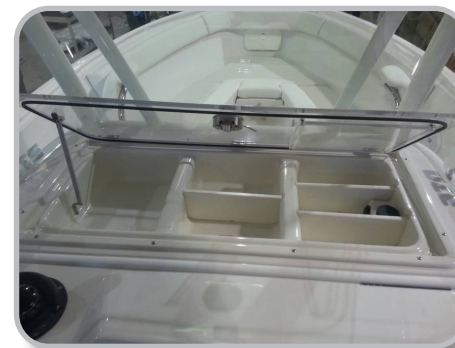

Key	Description
1	Lid Spring
2	MP3/USB and Headphone Jack
3	12 Volt Plug



Type III MSD Waste Management System

TECMA by **THETFORD**

FLUSH

ADD WATER

CAUTION

Prevent Pump Damage: Flush ONLY organic materials!

EMPTY BOWL

RETURN TO NORMAL USE

SET WATER LEVEL

1. Press & Hold

2. Symbols Flash

3. Release when water reaches desired depth

See Owner's Manual • Apply label to under toilet lid • Part No. 38592 Rev. A



Type III MSD Waste Management System

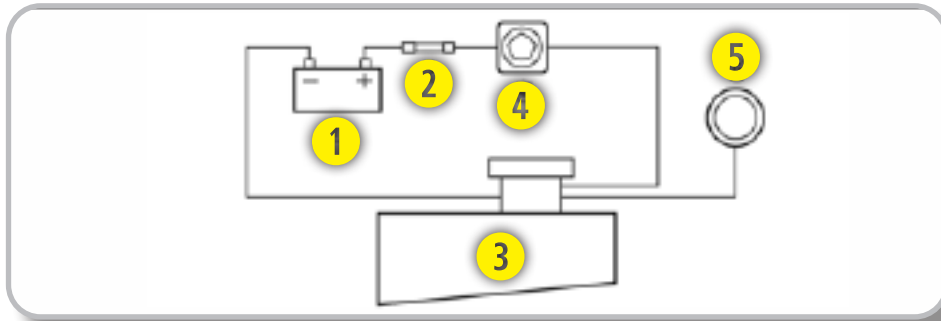

Key	Description
1	Battery
2	Fuse
3	Waste Management System
4	Master Switch
5	Controller for Waste Management System

Key	Description
1	Vent
2	Inlet
3	Toilet
4	Deck Pump Out
5	Overboard Discharge
6	Waste Holding Tank
7	Outlet

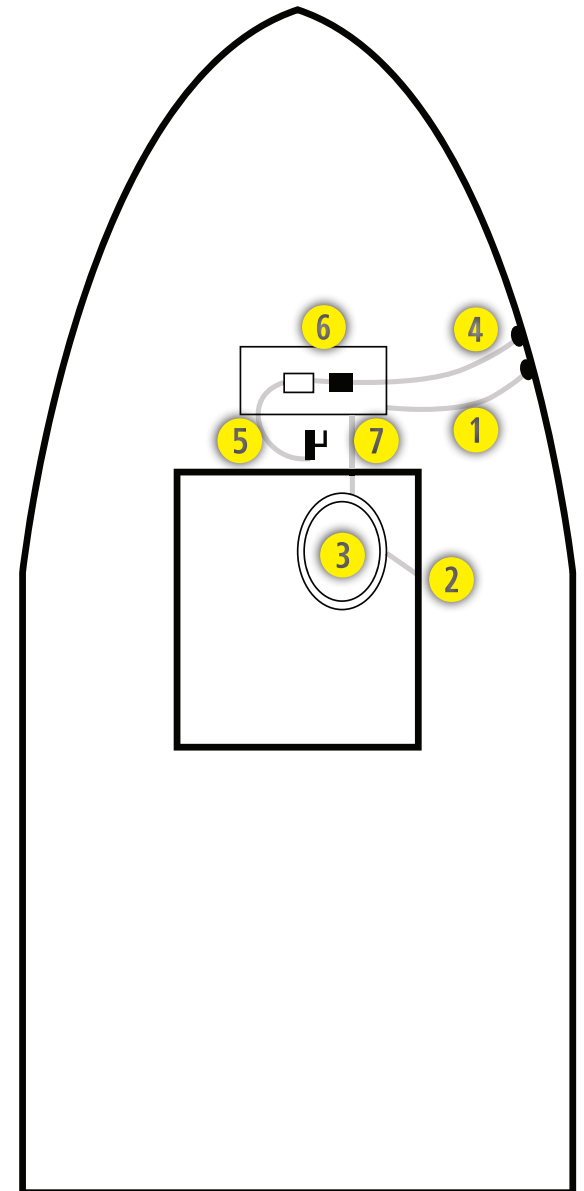



Cleaning

Use Thetford's Aqua-Clean, a non-abrasive all purpose cleaner, on the bowl and macerator pump. It is specially formulated and thoroughly tested to be safe for all components of your toilet system. It safely removes iron stains and hard water deposit and can be safely used on many other surfaces, including countertops, sinks, showers and tubs. Just squeeze Aqua-Clean onto surface. Allow to sit a few minutes and clean with a sponge. For severely soiled toilets, allow Aqua-Clean to soak overnight.

Never use household cleaners, which can contain bleach, in the toilet system. Household toilet bowl cleaners contain harsh acids. Bleach, petroleum based products, strong acids and abrasives can cause irreversible damage to the toilet system and components.

Winterizing

Use only propylene glycol based, non-toxic antifreeze when storing toilet during freezing conditions. Never use automotive antifreeze or windshield washer solvent to winterize.

Make sure that both the entire supply and discharge systems are thoroughly winterized to ensure complete protection for your system.

Storage

When Storing the system for more than two weeks, thoroughly clean toilet and hoses by flushing with Thetford's Aqua-Kem, EcoSmart or Aqua-Clean.



Access to the Marine Head Discharge Sea-cock is located in the Fwd head area on the floor, it is the same access plate used for the Fwd Bilge pump.

NOTE: This is a freshwater marine head system that runs off the boats freshwater tank, using the head will effect the boats freshwater supply.

Seasonal Start-up

Test the toilet before using by flushing the toilet to check operation. Verify that there are no leaks.

Deodorants

Thetford holding tank deodorants deliver exceptional deodorant performance, tank cleaning and waste digestion.

Formaldehyde-based deodorants like Thetford's Aqua-Kem deliver unsurpassed odor control even in the hottest conditions. Eco-Smart provides the best non-formaldehyde based odor control. Both are available as liquids in various sized bottles, granular in foil packets, and granular as water-soluble Toss-Ins.

EcoSmart, a liquid available only in a 32-oz bottle, provides enzyme based waste digestion and odor control.

Tissue

To facilitate flushing, it is recommended that you only use toilet tissues especially designed to disintegrate rapidly (unlike household tissues), such as Thetford's Aqua-Soft (2ply) and RV/Marine Toilet Tissue (1ply).

Type III MSD Waste Management System



07/13/2020

PROBLEM	CAUSE	ACTION / SOLUTION
Toilet does not flush or performance is poor	Waste tank is full	Empty waste tank before continuing to use toilet.
	Clog at pump inlet	Clear clog. DO NOT flush foreign objects.
	Solid object in macerator	DISABLE power. Attempt to remove object. if unsuccessful, contact Thetford Tecma Service (1-800-521-3032). DO NOT flush foreign objects.
	Low Voltage	Check that toilet supply voltage is 12V+/-2V (24V+/-2V) AND that there is no more than a 10% decrease in voltage when macerator is running. If voltage decreases more than this, there may be a wiring problem in the boat.
Water does not enter bowl during flush or water add cycle	Water supply line kinked or not connected	Check that supply line is properly connected to fresh water supply. Check for kinks in the supply line.
	No power to water pump	Check that fuse/circuit breaker has not tripped. Ensure all electrical connectors to water pump are fully mated.
	Water supply has been turned off	Open water supply valves or reconnect power to supply pump.
	Solenoid not plugged into relay module (where applicable).	Ensure wiring harness to solenoid is fully connected.
Water continues dripping briefly into bowl after flush cycle is complete	Toilet is installed below the water line with vented loop in water supply line	Normal operation – if only a small amount of water drips from the nozzle.
Bowl drains dry after flush	Water is siphoning out of bowl due to discharge hose pulled down.	Discharge hose from macerator pump is pulled down. Straighten hose so that top of discharge hose is in line with toilet nozzle



Note: This Troubleshooting guide is intended to provide a basic service aid in the case of incorrect toilet operation. If the suggested actions above do not resolve the issue, it may be necessary to bring unit in for professional service. Thetford Customer Service – 1-800-521-3032.



- Rugged Polyethylene holding tank
- Barbed fittings for all hose connections
- Heavy Duty Macerator
- Three run-dry and accidental activation safety features
- Evacuation Pump
- Touch-pad waste management control panel
- Additional dock side evacuation pick up

Pump Features	
Pump:	Self-Priming Flexible Impeller with Stainless Steel Wearplate
Impeller:	Jabsco Nitrile compound
Macerator:	Stainless Steel Cutter reduces particle size to 1/8" (3mm) maximum
Seal:	Lip Type
Ports:	Intec – 1-1/2: (38mm) Hose Barb and 1-1/2" N.P.T. (Male) Outer – 1" (19mm) Hose Barb
Motor:	Permanent Magnet Type, Fully Enclosed with Stainless Steel Shaft Includes Run-Dry Protection Device that shuts off pump. Powder coated housing with sealed end bolts and bearings.

System Features

Level Indication: When pressed, the level indicator will illuminate for 1 minute. When the tank level reaches full, the indicator will flash automatically to alert the user to empty the tank.

Sleep Mode: If the flashing LED is a disturbance, the unit can be put into sleep mode. The unit will emerge from sleep if the system is turned off or the tank level is increased. NOTE: the unit is unable to be put into sleep mode if the tank is 7/8 full or greater.

Empty Button: This button needs to be pressed and held for 3

seconds to activate the pump. This eliminates the possibility of accidental operation.

Averaging: Two different level averaging methods have been used – one when filling and one when emptying. This compensates for the boat's movement when the tank is filling, and still allows an accurate reading when emptying.

Fail Safe Feature: If no fluid movement is sensed 20 seconds after the pump is set to run, the pump will shut down and indicate a fault check pump and plumbing for a blockage.



Installation:

The holding tank should be located close to the toilet. A proper seacock is required if the discharge thru-hull is positioned below the waterline.

Both the discharge thru-hull and the holding tank are installed to prevent a potential siphon. Contact a marine plumber or Jabsco technical support specialist for installation assistance.

Mount on a strong flat surface. Note: the area of installation needs to support the weight of the unit and its contents.

Four mounting feet (included) need to be attached to the platform with four machine or lag screws and four flat washers.

Plumbing:

Each tank contains:

- 1 x 1 ½" deck pump out – evacuation pickup tube (Install to dockside pump-out deck plate)
- 1 X 1 ½" inlet port – from toilet system
- 1 x 3" O-ring sealed inspiration hatch
- 1 x 1" vent* - connect to vent outlet usually sited high on a vessel's hull near the gunwale
- 1 x 1" Overboard discharge port macerator pump out. Discharge: connect to the overboard discharge thru-hull fitting.

* See plumbing diagram for recommended installation.

Maintenance:

Flush system with clean water to remove any build up of sludge or debris. It is recommended that this process be completed at least once a year. Please reference 18590 Series Macerator datasheet servicing section for details.

Winter Storage:

Empty the complete system of all water making sure pipe work and pump are completely free of waste.



The fuses for both the marine head and the waste tank are located behind the dash in the first panel coming off the bus bar, pictured to the left.

Optional Porta Potti



07/13/2020

Prepare Unit

- Separate tanks (Fig. 1A & 1B).
- Add Deodorant (Fig. 2A & 2B) and 4-oz of water.
- Close valve (Fig. 2C).
- Recombine Tanks (Fig. 3)
- Fill upper tank with fresh water (Fig.4). Replace cap and tighten securely.

NEVER add deodorant to fresh water tank.

Before Use

Vent any built-up heat or altitude pressure and prevent splashing: close cover (Fig. 5A), and open and close holding tank valve (Fig. 5B).

To Flush

- Open Valve (Fig. 2A).
- Bellows: Fig. 6.
- Piston Pump: Fig. 7.
- Electric Flush: Fig. 8 For best rinse and efficient water use, press button quickly several times.
- Close valve completely for odor-tight seal (Fig. 2C).

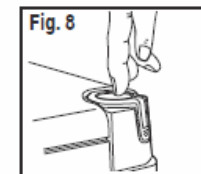
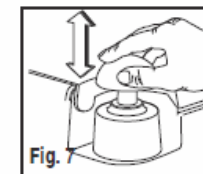
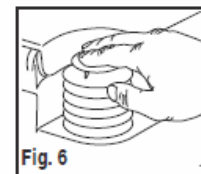
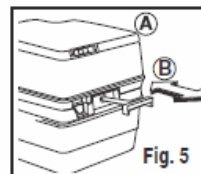
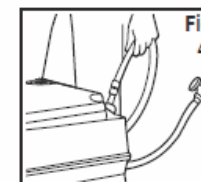
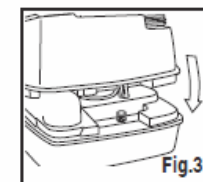
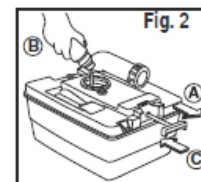
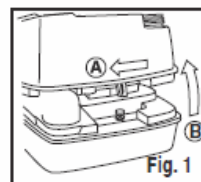

Deodorizing

Recommended holding tank deodorant for best performance:

Thetford SupremeGreen
Thetford Aqua-Kem
Thetford Campa-Chem



Care

Recommended cleaner:
Thetford Aqua-Clean

NEVER use scouring powders, acids or concentrated cleaners, which can damage plastic parts and rubber seals.



Service & Parts

For parts and/or service, contact your RV Dealer.

For warranty issues or more information, call Thetford's Customer Relations Department:
1-800-521-3032.



Emptying Waste Tank

1. DO NOT OVERFILL TANK. Empty when waste level indicator turns from green to red (Fig. 9). (Toilet without an indicator: open valve to check visually).
2. Be sure valve handle is closed. Separate tanks (Fig. 10).
3. Carry waste tank to a permanent toilet.
4. Remove Pour-Out Spout Cap while it is pointing upward (Fig. 11).
5. Press Air relief valve to prevent splashing (Fig. 12).
6. Rinse, recharge and reassemble unit.

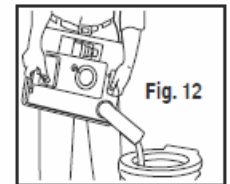
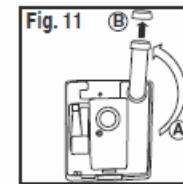
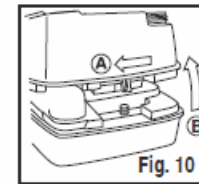
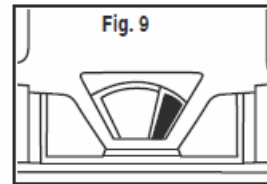

Deodorizing

Recommended holding tank deodorant for best performance:

- Thetford SupremeGreen
- Thetford Aqua-Kem
- Thetford Campa-Chem



Care

Recommended cleaner:
Thetford Aqua-Clean

NEVER use scouring powders, acids or concentrated cleaners, which can damage plastic parts and rubber seals.



Service & Parts

For parts and/or service, contact your RV Dealer.

For warranty issues or more information, call Thetford's Customer Relations Department:
1-800-521-3032.



Step-by-Step Cleaning Instructions

Type of Stain	Steps:	1	2	3
General Care		A	B	
Dirt Build-Up		A	B	
Ballpoint Ink*		E	B	A
Chewing Gum		D	A	
Coffee, Tea, Chocolate		B		
Grease		D	B	
Household Soil		A	B	
Ketchup		A	B	
Latex Paint		A	B	
Lipstick		A	B	
Mildew or Wet Leaves*		C	B	A
Motor Oil		B		
Oil-Based Paint		D	B	
Permanent Marker*		E	B	C
Spray Paint		B		
Suntan Lotion		A	B	
Tar / Asphalt		D	B	
Yellow Mustard		A	B	C

Legend

A. Medium-Soft brush, warm soapy water, Rinse / Dry

B. Vinyl Finish Vinyl Cleaner®, Rinse / Dry

C. One (1) table-spoon of ammonia; one-fourth (1/4) cup of Hydrogen Peroxide, three-fourth (3/4) cup of water, Rinse / Dry

D. Wipe or scrape off excess (chill gum with ice before hand)

E. Hemisphere Ink Remover, Rinse / Dry

Failure to care for your vinyl properly, or use of improper cleaners may void your warranty & damage your vinyl.

Do's & Don'ts

Do's

- Vinyl Finish Vinyl Cleaner
- Dish Soap (Dawn, Ivory)
- Fantastik
- 303 Aerospace Protectant

Don'ts

- Formula 409
- Murphy's Oil Soap
- Simple Green
- Armor All
- Son-of-a-Gun
- Turtle Wax / Tar Remover

All cleaning methods must be followed by a thorough rinse with clean warm water.

Certain household cleaners, powdered abrasives, steel wool, and industrial cleaners can cause damage and discoloration and are not recommended. Dry cleaning fluids and lacquer solvents should not be used as they will remove printed pattern and gloss. Waxes should be used with caution as many contain dyes or solvents that can permanently damage the protective coating. *Suntan lotion, tree pollen, wet leaves, and some other products can contain dyes that stain permanently.

***Always Remove Stains Immediately!**

Caring for Aluminum - Cosmetic Corrosion (Pitting)



07/13/2020

The information provided is designed to give you a thorough understanding of the factors that can impact the appearance of your anodized aluminum. By using this information, we hope to help you enhance the beauty and value of our products.

What Causes It?

Corrosion is a natural phenomenon that affects metals by either a chemical or electrochemical reaction. The rate at which aluminum corrodes depends greatly on the environmental conditions and

the amount of preventative maintenance performed. Our goal is to slow down or stop this natural phenomenon we call pitting (or corrosion).

Anodized Aluminum

The aluminum on your boat has been anodized. This creates a very hard protective seal on the surface of the aluminum to protect it as much as possible from pitting. When the anodized coating is broken and raw aluminum is exposed, corrosion will take place. Damage from

other abrasive impacts can break the anodized coating.

Chemical Attack

Corrosive chemicals containing high concentrations of acids or alkalis will remove the anodized coating. Solutions containing chlorine, salts, or ammonia are all harmful to the anodized aluminum on your boat. Many common household cleaners contain chemicals that will remove the anodizing and cause pitting.

Avoidable	Unavoidable
Strong acidic solutions found in cleaners, paint remover, degreasers, etc.	Airborne pollution. Airborne particles from local sources: vehicles, incinerators, paper mills, chemical plants, power plants, etc.
Concentrated alkaline based solutions. Many concentrated soaps fall into this category.	Harsh chemicals from work performed at local shipyards and dry docks.
Chlorine, sulfurs, solvents and ammonia based products.	Be aware of local sources that can expose your new boat to corrosive chemicals.





Tips

Avoid the use of bleach or chlorides to clean the aluminum or nearby components. Chlorides can leach onto the aluminum when used nearby.

Avoid abrasive cleaning products. Never use steel or brass wool, wire brushes, polishing wheels, rubbing or polishing compounds. These items will remove the anodizing and lead to pitting.

Protective Products

There are many different products available to protect aluminum. Some are designed to seal and protect before problems occur and others are designed to use after pitting has appeared.

While these products are effective, they are not one time solutions. Metal protectors must be reapplied on a regular basis. How often a protector should be used varies according to the protector you choose, the types of exposure your boat

is subjected to, and how often you use and wash your boat. Follow the application guidelines provided with the protector you choose.

Harmful Cleaners

Bleach (Clorox, etc.)
Mild abrasive cleaners (Ajax, Comet, Soft Scrub, Rubbing Compounds, etc.)
Strong cleaners (409, Engine Degreasers, Bilge Cleaners, Teak Cleaners, Bottom Cleaners, etc.)

Below are some metal protection products that are readily available at marine retailers.

Woody Wax CPR	Woody Wax woody-wax.com 800-619-4363
Boeshield T-9	PMS Products, Inc. boeshield.com 800-962-1732
Premier Polish	Aquatech aquatech-marine.com 800-853-7760
Corrosion Block	Lear Chemical learchem.com 800-256-2548





The information provided is designed to give you a thorough understanding of the factors that can impact the appearance of your anodized aluminum. By using this information, we hope to help you enhance the beauty and value to our products.

What Makes Stainless Steel Stainless?

Oxygen is the key element in causing rust, or red oxide on steel and other metals. Stainless Steel contains Chromium which reacts with the oxygen in the air to form a chrome-oxide surface layer that is invisible to the eye, but strong enough to prevent further oxygen from “staining” (rusting) the surface. Higher levels of Chromium and the addition of other alloying elements such as nickel and molybdenum enhance this surface layer and improve the corrosion resistance of the stainless material.

What Determines Different Grades of Stainless Steel?

The grade of Stainless Steel is primarily determined by the amount of the Chromium and Nickel alloys contained in the

material. 304 and 316 are the prominent grades of Stainless Steel: 304 contains 1% Chromium and 8% Nickel, while 316 Contains 16% Chromium and 10% Nickel and 2% Molybdenum. The Molybdenum is added to help resist corrosion to chlorides (like sea water and de-icing salts).

Can Stainless Steel rust?

Not in the way steel rusts. Steel will discolor, bubble and flake from red oxide development. Stainless Steel may develop red spots, but this is usually due to Iron particles on the surface of the Stainless Steel. Any Iron particles must be removed and the Stainless Steel cleaned with a high concentration of citric acid or a commercial cleaner specifically designed for Stainless Steel.

Is Stainless Steel Green (Environmentally Friendly)?

Stainless Steel is highly sought after by recyclers and is 100% recyclable. New Stainless Steel typically has a recycled content of between 65% & 80% which makes it one of the highest average con-

tent recycled construction materials on the planet.

Will Stainless Steel Discolor?

Cleaners that are typically used with cement, grout and stone, etc., may contain Muriatic Acid. Stainless Steel is not resistant to Muriatic Acid. MURIATIC ACID SHOULD NOT BE USED IF STAINLESS STEEL IS PRESENT. It is not even necessary that the acid touch the Stainless Steel, just the “fumes” from it will cause a discoloration of the Stainless Steel. Other than this, Stainless Steel is usually very resistant to discoloring.



Regular cleaning with fresh water and a soft cloth will keep and protect your windshield, window, or hatch for years.

GLASS

Use commercially available glass cleaners or a mixture of fresh water and vinegar. Do not use abrasives, harsh chemicals, or metal scrapers. Regular cleaning will help assure clarity of the glass for safe boating.

PLASTIC TYPE WINDSHIELDS

Never use glass cleaning solutions or dry cloth to clean Plexiglas. Never use acetone, benzene, carbon tetrachloride, or lacquer thinner. The only acceptable cleaners are a small amount of denatured alcohol, clean water, or a commercially available plastic polisher

specific for the purpose. Use a soft rag and wash off the plastic windshield first with lukewarm water to avoid scratching the surface.

WINDOW CHANNELS

Clean window channels with mild detergent only. Channels can be sprayed with silicon aerosol while sliding the glass back and forth.

STAINLESS STEEL

Polish with commercially available metal polishes. A boat or car wax periodically applied will offer extra protection against the elements.

PAINTED SURFACES

Clean with fresh water periodically. Touch up scratches and areas where paint has chipped off with touch-up

spray paint. Touch up kits are available from the factory. Boat top clips – never slide along windshield framework.

To change clip location, snap on and off the aluminum top track.

SIDE WING VENT ADJUSTERS

Use care when opening and closing vent. Do not force.

Never ground windshield with any electrical devices or appliances.

Never use the windshield as a mooring cleat for tying off to a dock, pier or another boat. Never use the windshield as a tie-off attachment for trailering purposes.



Your Boat's Gel Coat Finish

Congratulations! You are the proud owner of a new power or sail boat. You are also the owner of a new Integrity® gel coat finish on the hull and/or topside, and we would like you to be as proud of it as we are. That beautiful, shiny new color you love is the result of many years of gel coat research, testing and development.

But as proud as we are of the gel coat, no finish is totally impervious to chemicals and weathering. Imagine what a brand new car could look like if allowed to sit at a marina for years with no cover and no washing or waxing. With the same minimum maintenance you would ordinarily give your new automobile's finish, your boat's gel coat finish will retain its depth of color and gloss for years.

Overall Maintenance

Normal maintenance of your gel coated fiberglass boat is similar to the care you would give your automobile. Overall, automotive cleaners and waxes work fine, as well as the marine cleaners and waxes.

Note: Do not use caustic or highly alkaline (high pH) cleaners or those containing ammonia. These type of cleaners may darken white or off-white weathered gel coat surfaces. A chemical reaction producing staining occurs if these type of cleaners are used on weathered gel coat. However, the stain may be removed with a rubbing compound or by lightly sanding with 400 grit sandpaper followed by an application of rubbing compound and a thorough waxing.

Cleaning

We recommend general washing to avoid soil build-up and staining. The soil to your gel coat is the result of regular use and environmental pollutants such as soot and smog. Periodic cleaning with a mild detergent is necessary to remove normal deposits of soil.

Waxing

From constant exposure over time to our natural environment and undesired pollutants, the gel coat begins to lose its gloss. To restore your finish to the original gloss and color requires your special attention. After washing with a mild soap or detergent, give the surface a good

polishing with a self-cleaning marine or automotive wax. Waxing in the fall and spring is generally recommended to maintain and restore most of the original gloss. If the surface has not been maintained and has weathered badly, and if cleaning and waxing does not restore the finish satisfactorily, compounding will be required.

Compounding

Please see your marine dealer for advice. Polishing and compound (fine abrasive) or rubbing compound (coarser abrasive) is recommended for use on fiberglass boats to remove scratches, stains, or a severely weathered surface. Polishing or rubbing compound can be applied by hand or by pneumatic buffer. After the scratched, stained or weathered surface has been moved, it should be waxed to enhance the gloss and color while providing a seal to retard staining or new soil accumulation.

Discoloration Removal

Your marine dealer is best equipped and trained to do this work. If regular washing and waxing has been neglected, discoloration of the gel coated fiberglass surface may occur.



Discolored areas are very shallow in depth, literally right on the surface. The discoloration may be removed by gently wet-sanding the affected areas only by using 600 grit, wet or dry specially treated waterproof sandpaper. It's important to always sand in one direction, this includes the curves too. Use plenty of water to cool and clean the sandpaper and cut back on dust. After you are finished sanding, dry the areas and verify all the discoloration has been removed. If not, repeat the process.

After all the discoloration has been removed, the area will need to be buffed. Using an electrical or pneumatic buffer, buff at low speed (1750 rpm – 2250 rpm), this will restore the luster to the sanded surface. Using a generous amount of rubbing compound, apply it in a circular motion with a soft wool pad. When buffing has been completed, wash off the rubbing compound with clean water, and dry the surface.

To restore the gloss to the affected area, use a high-grade marine or automotive wax.

Repairs

During the life of your boat, some damage to the gel coat surface is unavoidable. We recommend repairs done by trained, experienced professionals at your local marine dealer.

Scratches

If the scratch is in the gel coat surface, not penetrating the fiberglass, use an automotive polishing compound and rub it out. Apply the compound by hand using a damp rag or by using a power buffer. The scratch may not entirely disappear, but it should be noticeably better.

Gouges and Chips

Our recommended patching procedure is to first clean the area needing repair with an acetone solvent to remove all traces of wax and oil. Next, thoroughly mix one tablespoon of "Patch Paste" with two or three drops of catalyst on a scrap piece of cardboard.

Apply the mixture to the pit, chip or gouge with a single-edge razor blade, matching the surface and contour of the area being

repaired. Apply slightly more mixture to avoid having to fill the damaged section a second time. Allow the patch to harden thoroughly for a minimum of two to three hours.

Using a fine grit "wet or dry" sandpaper on a sanding block, wet-sand the patch until it is level with the surrounding surface. Finish with a marine or automotive rubbing compound using the same approach as used for the scratches.

Refinishing

For a severely scratched or weathered fiberglass boat that is no longer restorable by using the previous methods, it may then be necessary to refinish it with two-pack-age or two-part aliphatic urethane enamel. This can be done very effectively, but it is recommended refinishing should only be done by experienced professionals.

