

SALTWATER[®]



**DEMAND
THE DIFFERENCE**



A photograph of a person in a white Sailfish boat on blue water. The boat is moving from left to right, leaving a white wake. The person is wearing a blue shirt and is looking towards the right. The background is a vast expanse of blue water under a clear sky.

Sailfish Boats – Fishing Focused and Family Friendly.

For over 25 years, Sailfish has provided the saltwater enthusiast with a full line-up of reliable, stylish, and user friendly boats capable of withstanding the rigors of the inshore and offshore environments.

DEMAND THE DIFFERENCE is more than just a slogan; it's a strategy to exceed customer's expectations. With a CSI rating always in the top 10 percent, and winner of the NMMA CSI Award 5 years in a row, customer satisfaction is a hallmark of Sailfish ownership.

At its core, Sailfish is a fishing boat – designed by anglers for anglers – loaded with more standard equipment for fishing enthusiasts than any other boat on the water. Multiple rod holders in front and rear, insulated fish boxes, and built-in tackle storage

are just some of the fishing friendly features that you'll find on every Sailfish boat.

Still, anglers do not live by fishing alone, and for that reason a Sailfish is designed to be a hard-core tournament fishing boat one day and a versatile family fun boat the next day. With comfortable full bow seating, stow away tables, abundant storage space and a retractable ski tow bar, your Sailfish provides for an exciting family day on the water.

With a reputation for quality and a history of innovation, Sailfish continues to be one of the premier saltwater fishing boats on the market and the best overall value. When it comes to your boating investment, shouldn't you **DEMAND THE DIFFERENCE?**

Exclusive VDS Hull Design

Only Sailfish boats feature the exclusive Variable Deadrise Stepped Hull – that improves lift and stability giving Sailfish Boats a smooth ride for all day enjoyment.

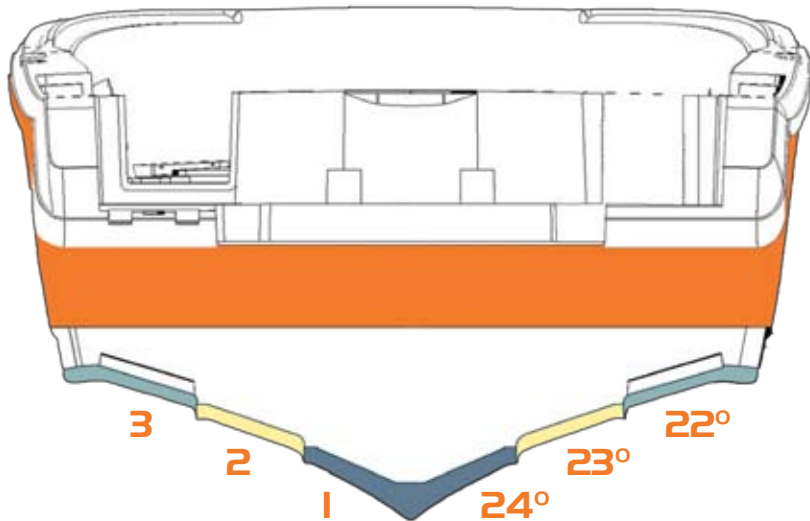

Three Hulls in One:

- The first hull cuts the water.
- The second hull combined with turn down strakes creates lift.
- The third hull creates stability.

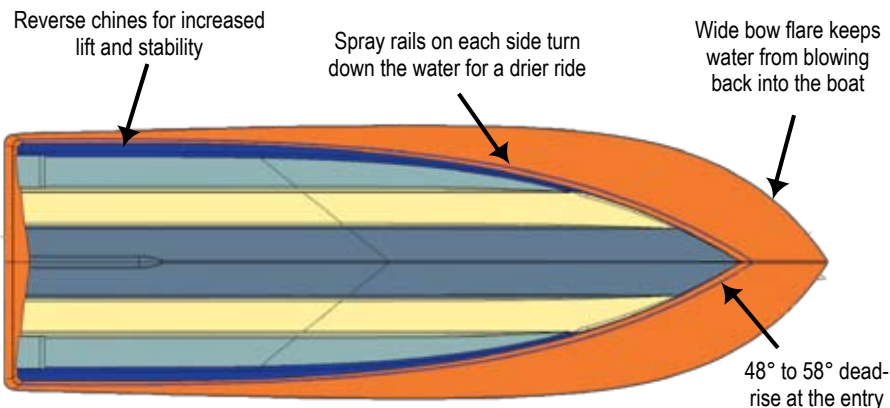

Demand The

Intelligent Ergonomic Design

The fact that Sailfish Boats seem to just “work” better is no accident. From the ergonomic layout of the helm and console to the deep gunwales and wide walkways from front to rear, every inch of every Sailfish model is planned and thought through for maximum utilization of available space. From strategic seat heights and raised footrests to strategically placed controls and instrumentation, everything is located to provide maximum ease of operation. That’s a “DIFFERENCE” you can feel every time you get on board.

Quality Construction – Built To Last!

Each Sailfish is quality built using only the best materials and proven manufacturing techniques – from start to finish there are no shortcuts taken in the manufacturing process. Kevlar® & carbon fiber reinforcements are added for durability, and the entire stringer system is foam-filled for added safety. Many standard features – such as rod holders, live wells and tackle storage compartments are molded directly into the boat for greater durability and ease of use. Our exclusive raised-dot, non-skid surfaces make for easier cleaning and maintenance – without back-breaking scrubbing on your hands and knees. All these “DIFFERENCES” are starting to add up.

100% Yamaha PowerMatched™ Components

All Sailfish boats are equipped standard with powerful, fuel-efficient Yamaha outboard motors and feature genuine Yamaha PowerMatched™ rigging components as standard equipment. On all models twenty-one feet and up, this feature extends rigging component warranties for a full three years. Compatibility means dependability – another Sailfish “DIFFERENCE”.

Difference

Unmatched Fit & Finish

It's the little things that make the difference between a good boat and a great boat. All Sailfish boats are finished using the best available gelcoats, masterfully applied and polished to a bright shine. All hinges and deck lids are recessed into the mounting surface leaving nothing protruding to stub your toe or cut your feet when barefoot. Our quality control is second to none; each Sailfish boat is painstakingly examined for flaws and imperfections before it leaves the plant – this attention to detail is another “DIFFERENCE” that separates Sailfish from other boat builders.

There Is Simply No Safer Boat On The Water.

From the 220 to the 320, Sailfish models offer the greatest cockpit depth in the industry, keeping water out and people in. Sailfish boats also feature the largest recessed, self-bailing cockpit drains in their class, allowing the maximum amount of water to exit the deck providing an extra measure of safety. Our standard strategically placed bow rails allow users to lower their center of gravity and better maintain balance in rough seas. An integrated rear telescoping ladder is standard on all 22 to 32 foot Sailfish models – this allows for easy access outside the boat – now that's a “DIFFERENCE” that can save a life.





320 CC

Serious offshore capability and dazzling style make the Sailfish 320CC the best performing big water boat we have brought to market. Our VDS hull design is the softest riding, driest hull in Sailfish history and the multiple deadrise, variable lift plane running surface, makes the 320CC both responsive, and extremely agile for a boat this size. But beyond the standards lies the real heart of Sailfish design, function, comfort, and practical ergonomics. Look over other brands in this size range, we think you'll agree that the Sailfish 320CC is the best of the best, and represents the clear choice in offshore fishing boats available at any price.

SALE FISH®



SPECIFICATIONS	U.S.	METRIC
LOA.....	31' 6"	9.6 M
Length Rigged	34'	10.4 M
Beam	10'	3.05 M
Fuel Capacity.....	300 Gal.....	1,135.62 L
Fresh Water.....	21 Gal.....	79 L
*Approx. Wet Weight	10,500 Lbs.....	4,763 kg
Cockpit Depth Rear	31"	78.74 cm
Cockpit Depth Front.....	40"	102 cm
Max. Hp w/ Twins	600 Hp.....	522 kw
Draft - Hull	22"	55.88 cm
Deadrise (Variable).....	22° - 24°	
Bridge Clearance w/ T-Top	106"	2.69 m
Battery Capacity	3	
Person Capacity	Yacht Certified	

*With the Base Motor Package

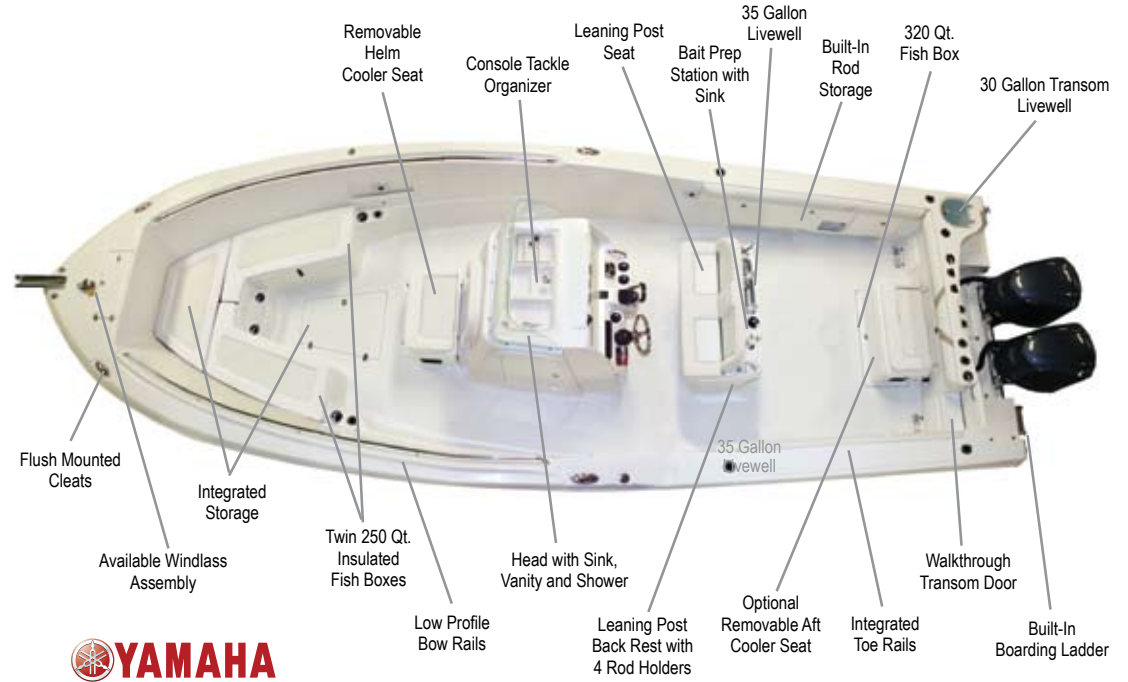



320 EXP

320

Serious offshore capability, a fully appointed cabin with berths for 6 or more, and dazzling style, combine to make the Sailfish 320 Express the sport utility of the sea. Whether cruising to dinner, or fishing the gulf stream, this boat provides the lifestyle you've always dreamed about. Standard fishing amenities include 13 upright rod holders, 30 gallon live well with high speed pickup, 2 deluxe tackle stations, and much more. Cruising features include enclosed shower/ head, fold down bunks, aft berth, refrigerator, stove, microwave, shore power and hot water heater. Riding on the best performing hull design in the industry, the world is at your beck and call with the Sailfish 320 Express.

SALE FISH®

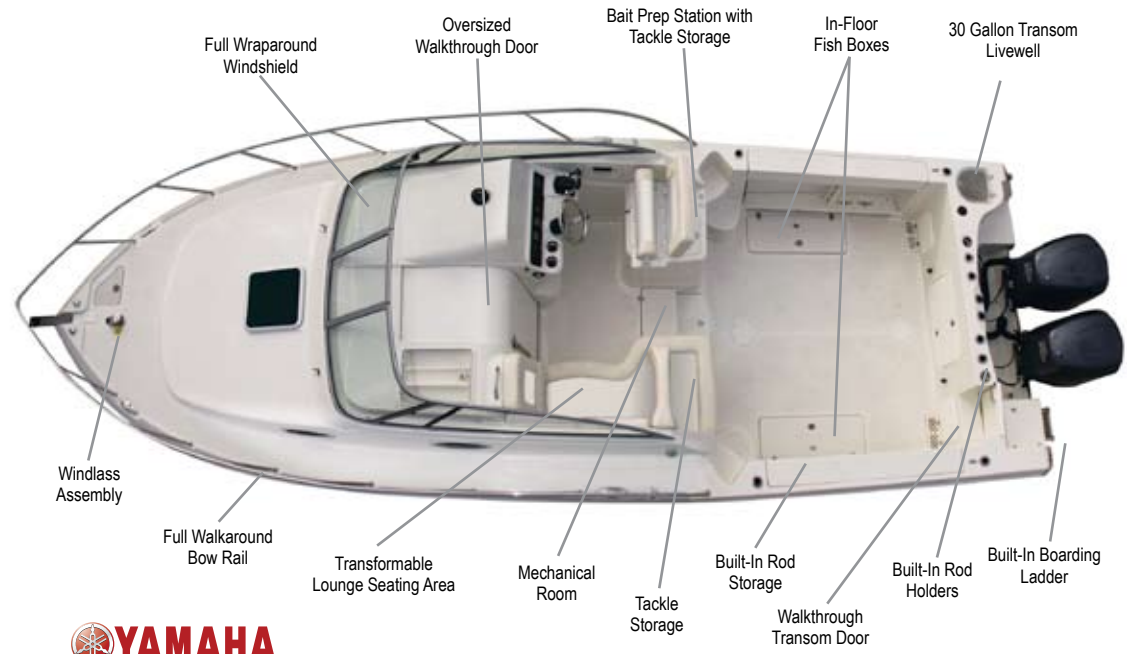

SPECIFICATIONS

	U.S.	METRIC
LOA.....	31' 6"	9.6 m
Length Rigged	34'	10.4 m
Beam	10'	3.05 m
Fuel Capacity.....	300 Gal.....	1,135.62 L
Fresh Water.....	21 Gal.....	79.49 L
*Approx. Wet Weight	11,850 Lbs	5,375 kg
Cockpit Depth Rear	31"	78.74 cm
Cockpit Depth Front.....	40"	102 cm
Max. Hp w/ Twins	600 Hp	522 kw
Draft - Hull	22"	55.88 cm
Deadrise (Variable).....	22° - 24°	
Bridge Clearance w/ T-Top	115"	2.921 m
Battery Capacity	3	
Person Capacity	Yacht Certified	

*With the Base Motor Package





290 CC

290

The new 290CC has enormous offshore capabilities, and plenty of dazzling style. With the proven VDS high performance hull design, this boat is one of the driest, softest riding 29 footers on the market today. Loaded with standard fishing amenities, including 16 rod holders, 35 gallon leaning post live well, 30 gallon transom live well with high speed pickup, four fish boxes in the floor, rod storage and much more. The 290CC also boasts more available options to accommodate your everyday family needs as well as your tournament needs.



SPECIFICATIONS	U.S.	METRIC
LOA Hull Only	28' 6"	8.7 m
Length Rigged	30' 6"	9.3 m
Beam	9'	2.75 m
Fuel Capacity	240 Gal	908.5 L
Fresh Water	14 Gal	.53 L
*Approx. Wet Weight	8,000 Lbs	3,629 kg
Cockpit Depth Front	40"	76.2 cm
Cockpit Depth Rear	30"	1.01 m
Max. Hp w/ Twins	600 Hp	447.42 kw
Draft - Hull	21"	53.3 cm
Deadrise (Variable)	22° - 24°	
Battery Capacity	3	
Bridge Clearance	106"	2.7 m
Person Capacity	Yacht Certified	

*With the Base Motor Package

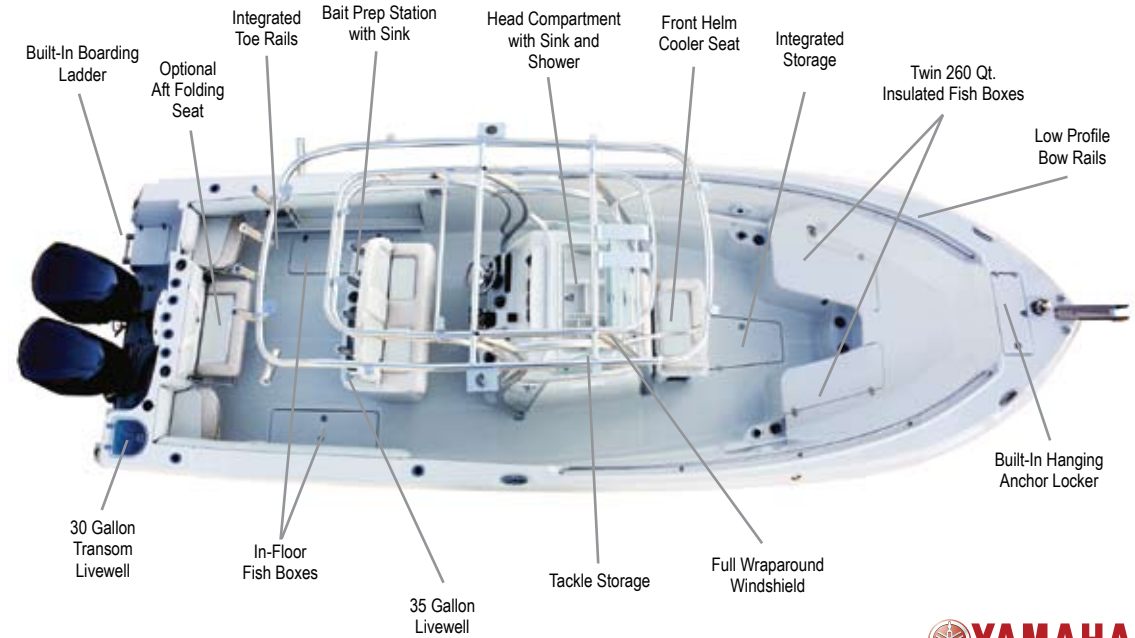



270 WAC

The 270WAC is designed to be the most accommodating and fishable walk around cuddy cabin on the market. The spacious cockpit includes standard livewell, fish box and rod holders galore. For extended overnights, the 270WAC cabin can be equipped with convenient amenities and includes a full stand up enclosed head and shower. Ample headroom, functional galley and a large v-berth makes for a comfortable stay. The 270WAC rides on the proven VDS Sailfish hull for the smoothest ride in offshore fishing. All in all, this new Sailfish is an impressive combination of comfort and utility sure to please the serious angler or weekend boater.

SALE FISH®

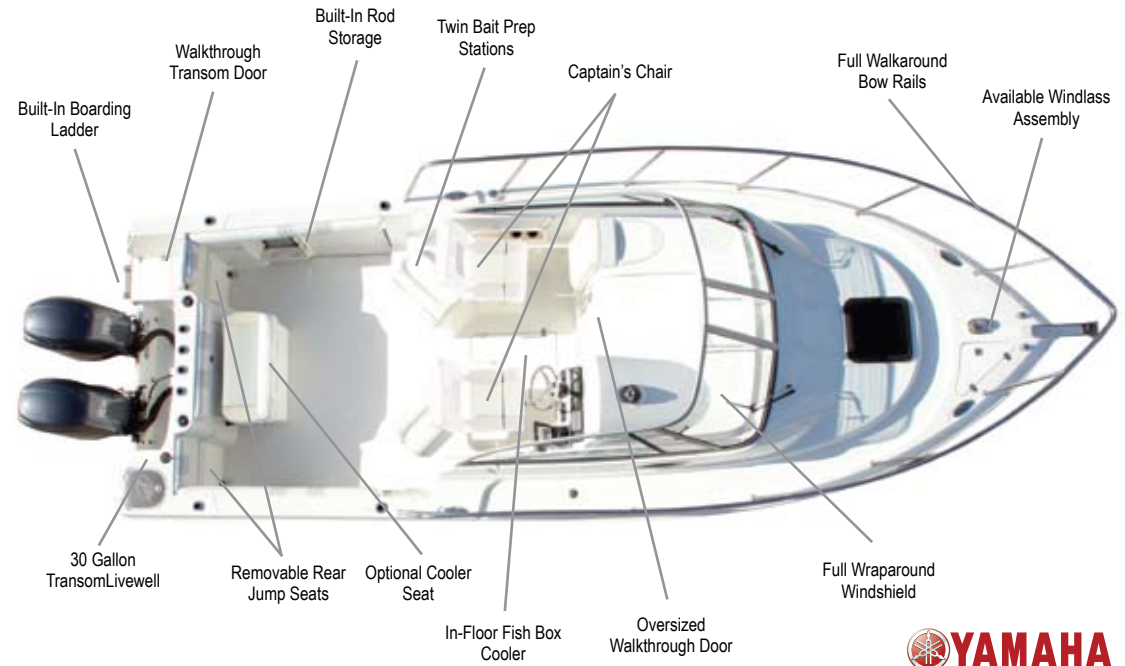

SPECIFICATIONS

	U.S.	METRIC
LOA Hull Only	26' 2"	7.97 m
Length Rigged	28' 2"	8.55 m
Beam	9'	2.74 m
Fuel Capacity	200 Gal	757 L
Fresh Water	14 Gal	52 L
*Approx. Wet Weight	7,400 Lbs	3,357 kg
Cockpit Depth Rear	30"	76.2 cm
Cockpit Depth Front	32"	81.2 cm
Max. Hp w/ Twins	500 Hp	450 kw
Draft - Hull	18"	45.72 cm
Deadrise (Multi Angle)	22° - 24°	
Bridge Clearance	107"	271.78 cm
Battery Capacity	3	
Person Capacity	Yacht Certified	

*With the Base Motor Package





270 CC

270

The 270CC is one of our most popular size fishing platforms. From the newly designed helm, to the expanded cockpit area, the 270CC is the largest and most user friendly boat in its class. Like all of the Sailfish boats, the 270CC incorporates the Sailfish VDS multiple deadrise. This high performance hull design makes for one of the softest riding, best performing boats on the market. Loaded with standard equipment, not to mention the largest selection of options available. It's no wonder the Sailfish 270CC is the best selling boat in its class.

SAULFISH®

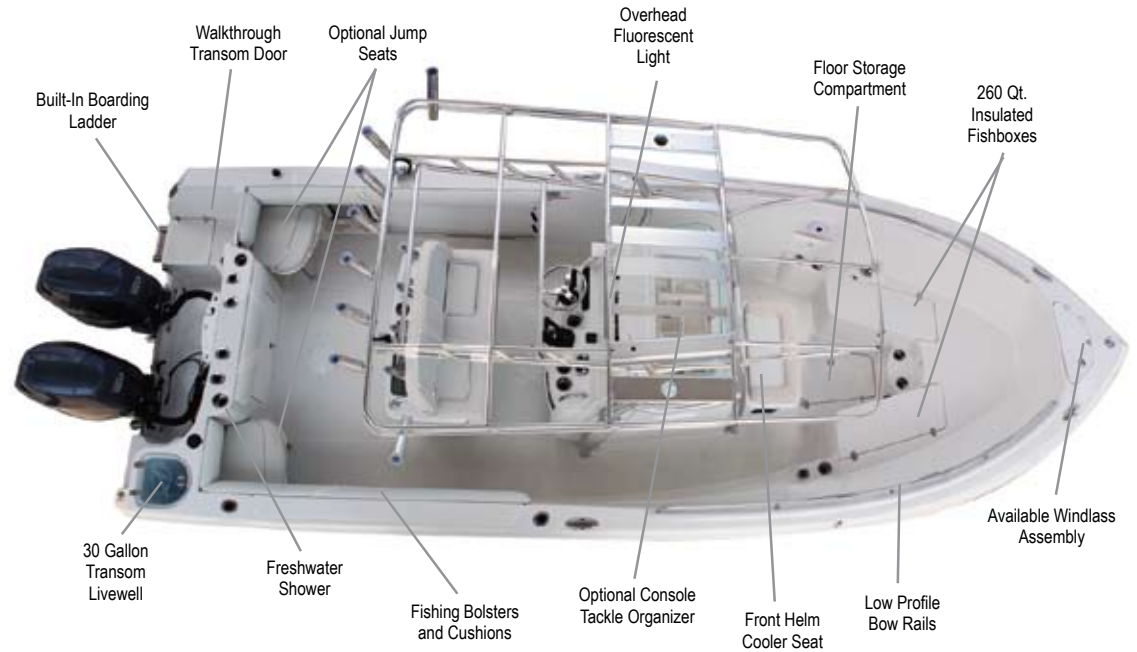

SPECIFICATIONS

	U.S.	METRIC
LOA Hull Only	26' 2"	7.93 m
Length Rigged	28' 2"	8.54 m
Beam	9'	2.74 m
Fuel Capacity	200 Gal	756 L
Fresh Water	14 Gal	53 L
*Approx. Wet Weight	6,700 Lbs	3,039 kg
Cockpit Depth Rear	30"	76.12 cm
Cockpit Depth Front	40"	101.6 cm
Max. Hp w/ Twins	500 Hp	450 kw
Draft - Hull	18"	45.72 cm
Deadrise (Variable)	22° - 24°	
Bridge Clearance w/ T-Top	102"	259.08 cm
Battery Capacity	3	
Person Capacity	Yacht Certified	

*With the Base Motor Package





240 WAC

The Sailfish 240WAC represents the most innovative cabin boat in its class. Developed on our world class VDS hull, renowned for superb performance and handling, the 240WAC is loaded with all of the top end amenities that Sailfish customers have come to expect. Not only is this the largest boat in the class, the new 240WAC's can be equipped as a competition quality fishing rig or optioned out to a luxury cruiser. Innovative design, maximized storage, and attention to detail make the Sailfish 240WAC the standard to which all must compare. Sailfish has built its reputation by delivering what the consumer demands. You too should "DEMAND THE DIFFERENCE", demand the new Sailfish 240WAC today.

SAILFISH®

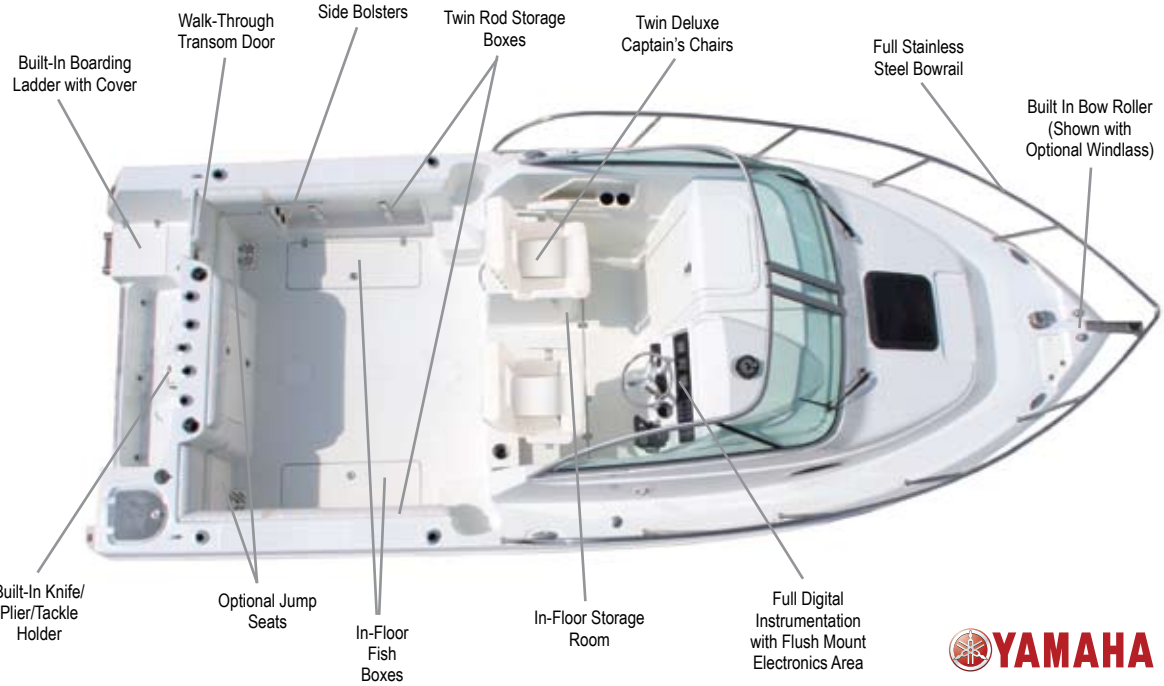

SPECIFICATIONS	U.S.	METRIC
LOA Hull Only	23' 6"	7.2 m
Length Rigged	25' 6"	7.8 m
Beam	9'	2.8 m
Fuel Cap	153 Gal	579 L
Fresh Water	14 Gal	53 L
*Approx. Wet Weight	6,350 Lbs	2,880 kg
Cockpit Depth Rear	29"	74 cm
Max Hp w/ Twins	300 Hp	223 kw
Max Hp Single	300 Hp	223 kw
Draft	18"	46 cm
Deadrise (Multi-Angle)	22 - 24°	
Bridge Clearance w/ Hard Top	105"	2.67 m
Battery Capacity	3	
Person Capacity	10	

**With the Base Motor Package*



SAILFISH®

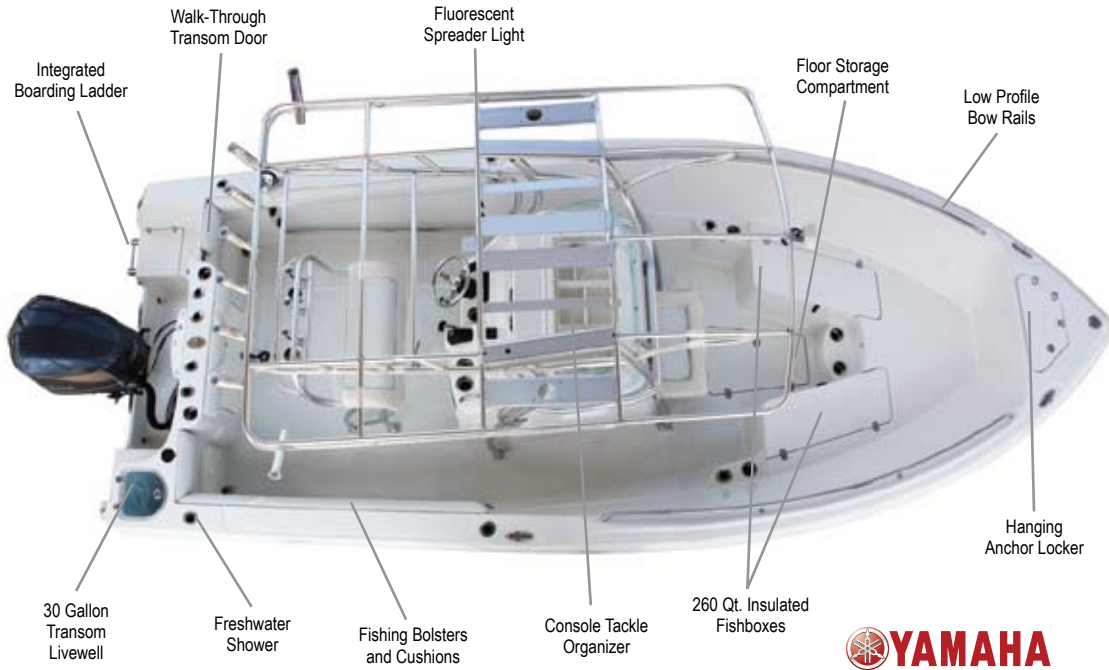

SPECIFICATIONS

	U.S.	METRIC
LOA	23' 6"	7.2 m
Length Rigged	25' 6"	7.8 m
Beam	9'	2.8 m
Fuel Cap	153 Gal	579 L
Fresh Water	14 Gal	.53 L
*Approx. Wet Weight	5,600 Lbs	2,880 kg
Cockpit Depth Rear	30"	76.2 cm
Cockpit Depth Front	40"	101.6 cm
Max Hp w/ Twins	300 Hp	223 kw
Max Hp Single	300 Hp	223 kw
Draft	18"	45.72 cm
Deadrise (Multi Angle)	22 - 24°	
Bridge Clearance w/ Hard Top	102"	259.08 cm
Battery Capacity	3	
Person Capacity	10	





240 CC

240

You asked for it and we listened. This venerable Sailfish 24 footer is available with twin outboards or a single outboard. Increased cockpit space, newly redesigned helm, and enough standard equipment to make your mouth water have made the Sailfish 240CC one of the top-selling 24-foot center consoles on the market. Available in multiple eye-catching hull colors and a huge variety of options and accessories, the 240CC can be delivered to your exact specifications.

SAIFISH®

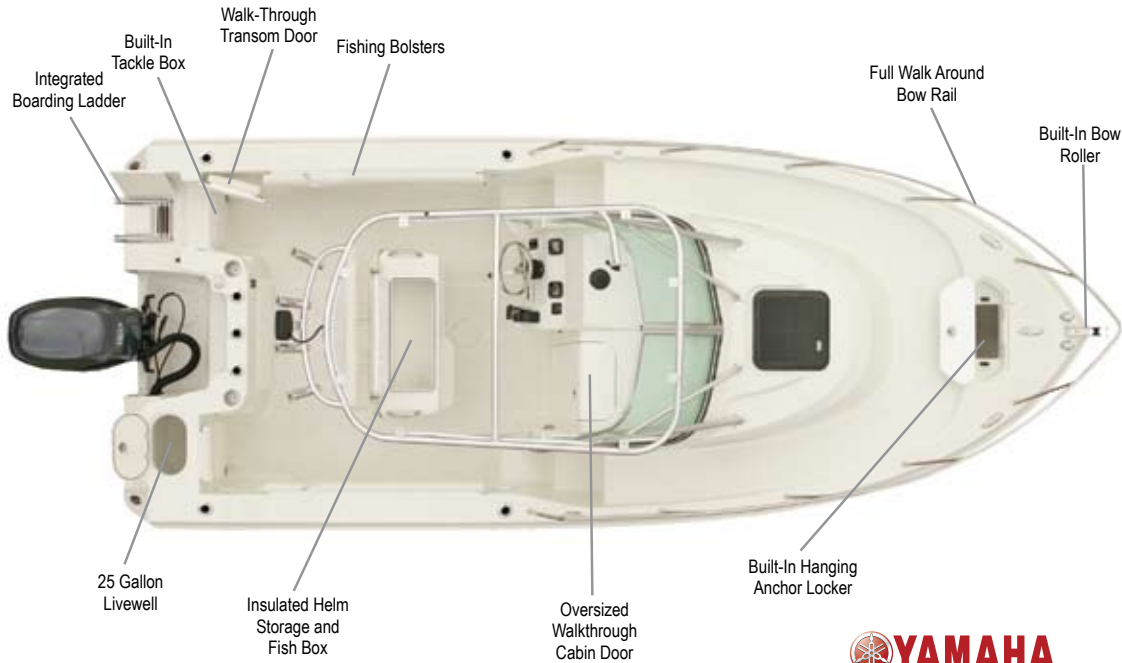

SPECIFICATIONS

	U.S.	METRIC
LOA	21' 3"	6.48 m
Length Rigged	23' 6"	7.16 m
Beam	8' 6"	2.59 m
Fuel Capacity	95 Gal	359.61 L
Fresh Water	6 Gal	22 L
*Approx. Wet Weight	4,950 Lbs	2,245 kg
Cockpit Depth Rear	26"	66.04 cm
Max. Horsepower	250 Hp	187 kw
Draft - Hull	18"	45.72 cm
Deadrise (Multi Angle)	22° - 24°	
Bridge Clearance w/ Hard Top	100"	254 cm
Person Capacity	8	

**With the Base Motor Package*





220 WAC

220

If you want the feel of a center console with the comfort of a walk around cuddy, the Sailfish 220WAC is the boat for you and your family. A spacious cabin equipped with overnight amenities and all of the fishing features you could ever need, combined with proven Sailfish big water performance, put the 220WAC in a class of its own. With a large variety of options and accessories available, you can customize a 220WAC to fit your lifestyle.



220 CC

The sailfish 220CC is one of the most popular 22-foot center consoles on the market. Talk to anyone who owns a 220CC and you'll find a true believer in the brand. An excellent ride in both smooth and rough seas, the 220CC sets the standard for all other boats in the class. Equipped for fishing or family fun, the 220CC is ready to go. Ample standard equipment, along with multiple options and accessories allow you to have the boat of your dreams in a package that's easily towed and as versatile as it gets. Test ride one today, you'll see what we mean.

SALEFISH®

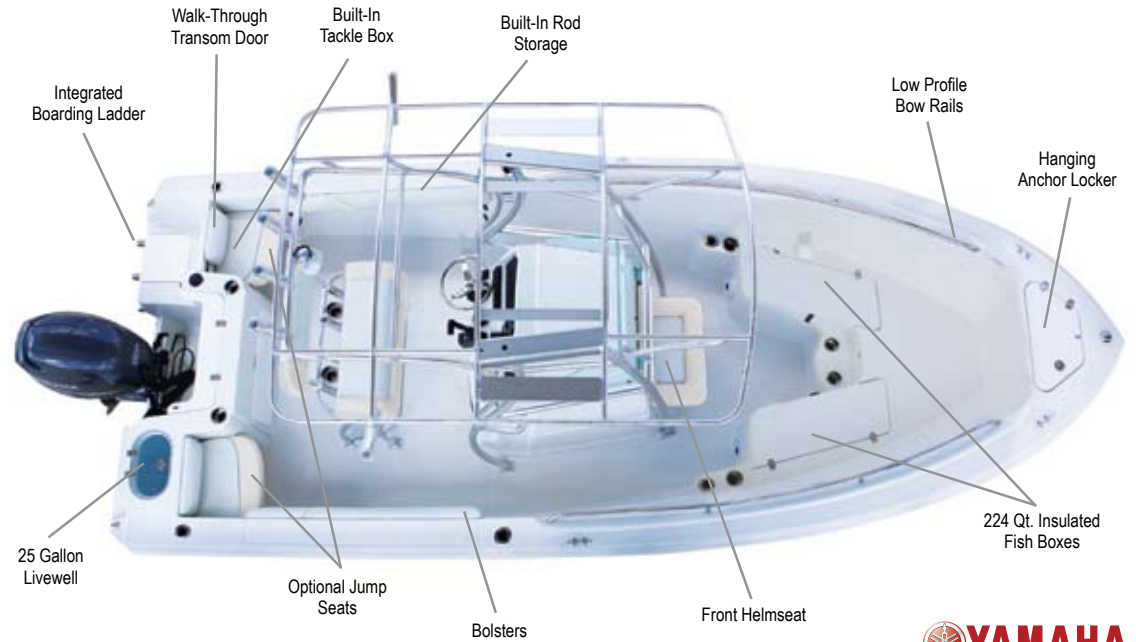

SPECIFICATIONS

	U.S.	METRIC
LOA Hull Only	21' 3"	6.48 m
Length Rigged	23' 3"	7.08 m
Beam	8' 6"	2.59 m
Fuel Capacity	95 Gal	359.61 L
*Approx. Wet Weight	4,450 Lbs	2,018 kg
Cockpit Depth Rear	26"	66.04 cm
Cockpit Depth Front	32"	81.28 cm
Max. Horsepower	250 Hp	186.43 kw
Draft - Hull	18"	45.72 cm
Deadrise (Multi Angle)	22° - 24°	
Bridge Clearance w/ T-Top	100"	254 cm
Person Capacity	8	

*With the Base Motor Package



SAIUFISH®

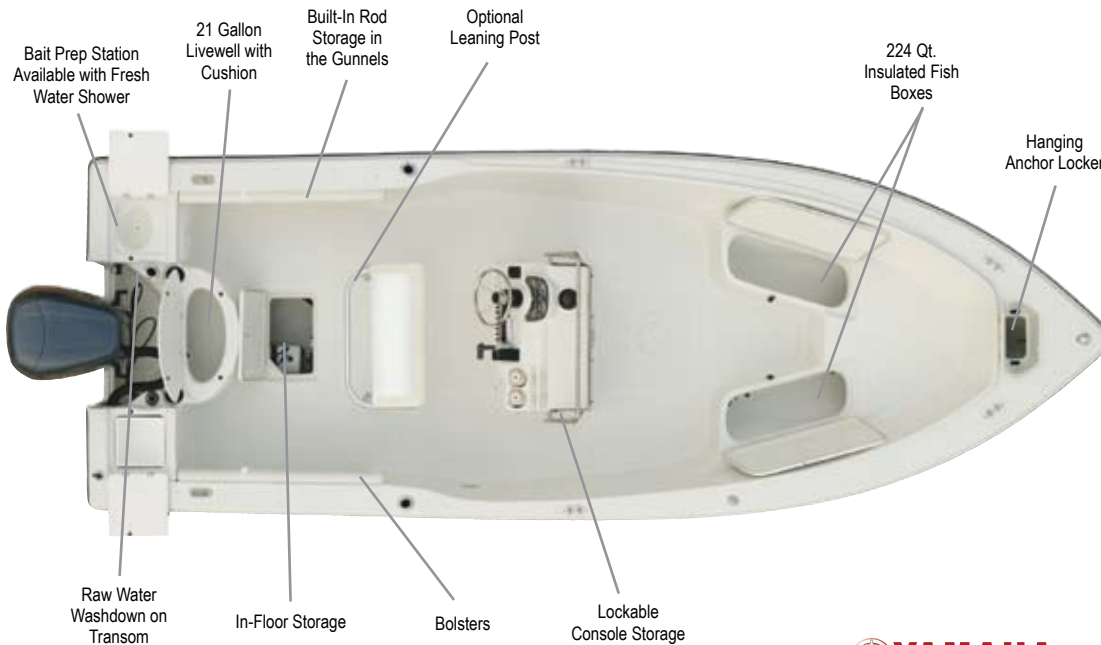

SPECIFICATIONS

	U.S.	METRIC
LOA Hull Only	20' 2"	.6.15 m
Length Rigged	22' 2"	.6.76 m
Beam	91"	.2.31 m
Fuel Capacity.....	63 Gal.....	238.48 L
*Approx. Wet Weight	3,275 Lbs	1,690 kg
Max. Horsepower	200 Hp	149 kw
Draft.....	12"	.53.34 cm
Deadrise (Variable).....	19°-21°	
Bridge Clearance w/ T-Top	98"	.248.92 cm
Person Capacity	6	

**With the Base Motor Package*





208 CC

208

The Sailfish 208CC has delighted anglers and families alike for years. The versatile 208CC works as well offshore as it does on the flats. Classic design, functional standard equipment, and a variety of optional accessories allow you to customize your 208CC to your exact needs. Don't let the size fool you! Many expert anglers swear by the 208CC; it's a lot of boat in a very manageable size.

SAILFISH®

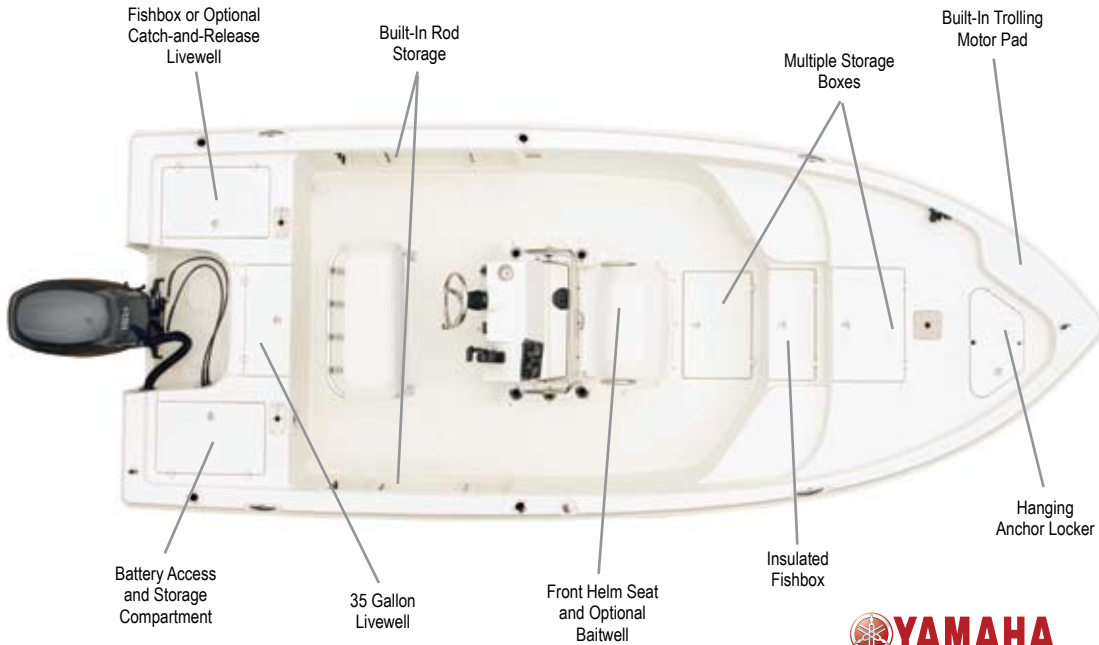

SPECIFICATIONS

	U.S.	METRIC
LOA Hull Only21'	.6.40 m
Length Rigged23'	.7.01 m
Beam8' 6"	.2.59 m
Fuel Capacity63 Gal	.238.48 L
*Approx. Wet Weight3,625 Lbs	.1,644 kg
Max. Horsepower200 Hp	.149.14 kw
Draft - Hull13"	.33.02 cm
Deadrise18°	
Bridge Clearance65"	.165.1 cm
Person Capacity7	

**With the Base Motor Package*





2100 BB

If you want the most versatile 21-foot bay boat on the market, then Sailfish 2100BB is for you. This boat is adaptable to both fresh and saltwater elements – inshore or offshore. The aggressive 18° deadrise hull means a soft ride in big water. The 2100BB is an angler’s dream with features like large front and rear casting decks, 12 rod holders, multiple storage locations, and the capacity of three live wells. The 2100BB can be tailored to fit with multiple helm seating styles to meet and exceed your expectations.

SAIURISH®

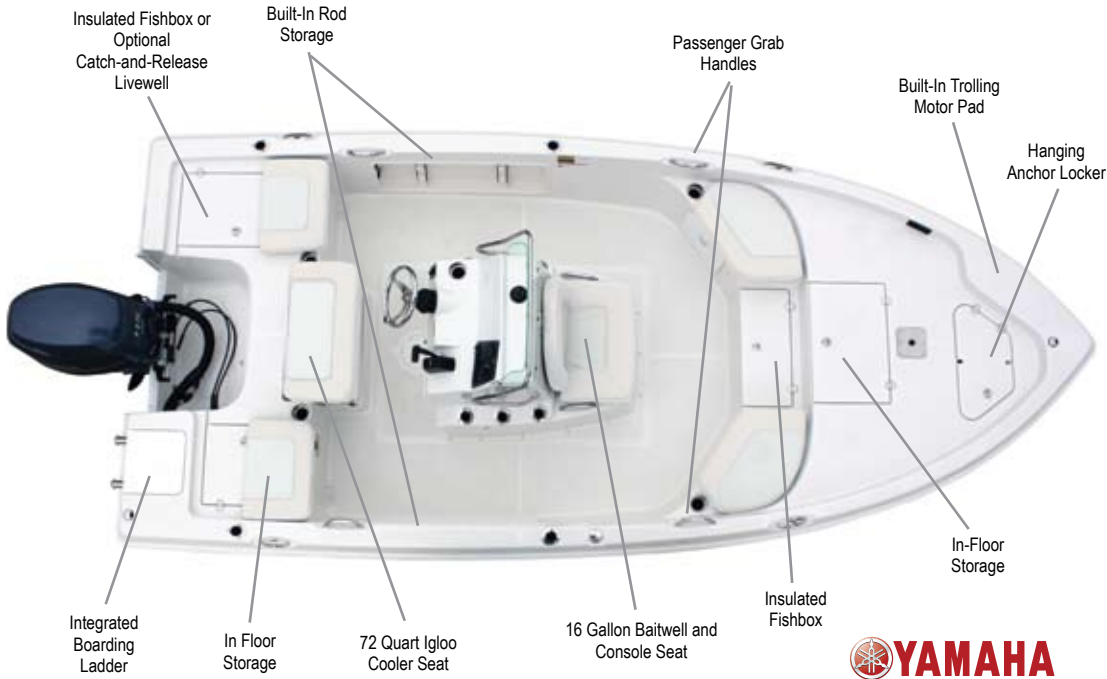

SPECIFICATIONS

	U.S.	METRIC
LOA Hull Only	19'	5.79 m
Length Rigged	21'	6.40 m
Beam	8' 6"	2.59 m
Fuel Capacity.....	52 Gal.	197 L
*Approx. Wet Weight	2,750 Lbs	1,248 kg
Max. Horsepower	150 Hp	112 kw
Draft - Hull	13"	33.02 cm
Deadrise	18°	
Bridge Clearance.....	65"	165.1 cm
Person Capacity	5	

**With the Base Motor Package*





1900 BB

The Sailfish 1900BB redefines the multipurpose bay boat. An aggressive 18° deadrise hull with 21" deep sides, standard 16-gallon bait well, optional catch and release live well, and abundant storage means you're ready for a full day fishing trip. The 1900BB is by far the most versatile boat in its class, with seating capacity for 5 and easy access built-in boarding ladder. It doesn't matter if you're a weekend warrior or a professional angler, on the lake or in the bay, inshore or offshore, the 1900BB gets the job done.

Get Your Sailfish Just The Way You Want It!

Each Sailfish boat comes with an impressive array of standard features, but you can add from our menu of options and special packages to build your Sailfish just the way you want it.

Either choose from our menu of individual options, or take special discounts on one of our optional packages designed to make your Sailfish work for the way you're planning to use it.



Features & Options	320 CC	320 EXP	290 CC	270 WAC	270 CC	240 WAC	240 CC	220 WAC	220 CC	208 CC	2100 BAY	1900 BAY
ELECTRICAL												
12 Volt DC Accessory Plug	•	•	•	•	•	•	•	•	•	•	•	•
Accessory Switch Panel w/Circuit Breakers	•	•	•	•	•	•	•	•	•	•	•	•
Battery Switch 1 or 2	2	2	2	2	2	2	2	1/D	1/D	1/D	1/D	1/D
Built-in Battery Charger	OPT	•	OPT	OPT	OPT	OPT	OPT	OPT	OPT	OPT	OPT	OPT
Cockpit Courtesy LED Lights	•	•	•	•	•	•	•	•	•	•	•	•
Compass	•	•	•	•	•	•	•	•	•	•	•	•
Electric Horn	•	•	•	•	•	•	•	•	•	•	•	•
Engine(s) Emergency Shut-Off Switch	•	•	•	•	•	•	•	•	•	•	•	•
Full Instrumentation With Yamaha Digital Gauges	N/A	N/A	N/A	N/A	N/A	N/A	N/A	N/A	N/A	OPT	•	•
Full Instrumentation With Yamaha Command Link Gauges	•	•	•	•	•	•	•	•	•	•	N/A	N/A
Yamaha Command Link Plus Gauge	OPT	OPT	OPT	OPT	OPT	OPT	OPT	N/A	N/A	N/A	N/A	N/A
Stereo AM/FM with MP3 & USB ports	OPT	•	OPT	•	•	•	•	•	•	•	•	•
Stereo AM/FM/CD Player W/ Satellite Radio Receiver	N/A	OPT	N/A	OPT	N/A	OPT	N/A	OPT	N/A	N/A	N/A	N/A
Remote Control for Stereo AM/FM/CD Player	OPT	•	OPT	•	•	•	•	•	•	•	•	•
Under Water LED Lights	3/OPT	3/OPT	3/OPT	3/OPT	3/OPT	3/OPT	3/OPT	2/OPT	2/OPT	2/OPT	2/OPT	2/OPT
PLUMBING												
Automatic Bilge Pump	3/STD	3/STD	3/STD	2/STD	2/STD	2/STD	2/STD	•	•	•	•	•
Bronze Garboard Drain Plug	•	•	•	•	•	•	•	•	•	•	•	•
Freshwater Shower	3	3	3	3	2	2	2	2	•	OPT	N/A	N/A
10 Micron Yamaha Fuel Filter/Water Separator (Yamaha O/B Only)	•	•	•	•	•	•	•	•	•	•	•	•
High Speed Livewell Pickup	•	•	•	•	•	•	•	•	•	•	•	•
Fresh Water Marine Head With Holding Tank & Overboard Discharge	OPT	•	OPT	OPT	OPT	OPT	OPT	N/A	OPT	N/A	N/A	N/A
Portable Marine Head	OPT	N/A	OPT	•	OPT	OPT	OPT	•	OPT	OPT	N/A	N/A
Raw Water Washdown	•	•	•	•	•	•	•	•	•	•	•	•
Self Bailing Cockpit	•	•	•	•	•	•	•	•	•	•	•	•
HARDWARE												
Marine Grade Hardware - Stainless Steel	•	•	•	•	•	•	•	•	•	•	•	•
Bow Anchor Roller	•	•	OPT	•	OPT	•	•	•	•	•	N/A	N/A
Engraved Transom Plate	•	•	•	•	•	•	•	•	•	•	•	•
Flush Mounted Bow Light	N/A	N/A	OPT	N/A	OPT	N/A	OPT	N/A	OPT	OPT	OPT	N/A
Flush Mounted Cleats	•	•	OPT	•	OPT	OPT	OPT	OPT	OPT	OPT	OPT	OPT
Flush Mounted Hinges & Deck Plates	•	•	•	•	•	•	•	•	•	•	•	•
Heavy Duty Stainless Steel Rub Rail	•	•	•	•	•	•	•	•	•	•	•	•
Heavy Duty Stainless Steel Bow & Stern Eyes	•	•	•	•	•	•	•	•	•	•	•	•
Ski Tow Bar Retractable	N/A	N/A	OPT	OPT	OPT	OPT	OPT	OPT	OPT	N/A	N/A	N/A
Stainless Full Bow Rail	N/A	N/A	OPT	•	OPT	•	OPT	•	OPT	OPT	N/A	N/A
Stainless Split Low Profile Bow Rail	•	N/A	•	N/A	•	N/A	•	N/A	•	OPT	N/A	N/A
Stainless Steel & Bronze Thru Hull Fittings	•	•	•	•	•	•	•	•	•	•	•	•
Stainless Steel Propeller(s)	•	•	•	•	•	•	•	•	•	•	•	•
Stainless Steel Rod Holders	12/STD	10/STD	7/STD	6/STD	6/STD	5/STD	6/STD	4/STD	4/STD	4/STD	8/STD	8/STD
Total Standard Rod Holders	30	19	17	16	12	9	12	10	12	8	14	14
SEATING												
Aft Seating	OPT	OPT	OPT	OPT	OPT	OPT	OPT	OPT	OPT	•	OPT	OPT
Baitwell Cushion	N/A	N/A	N/A	N/A	N/A	N/A	N/A	N/A	N/A	•	STD/OPT	•
Bow Cushions	OPT	N/A	OPT	N/A	OPT	N/A	OPT	N/A	OPT	•	N/A	N/A
Bow Cushion Back Rest Bolsters	OPT	N/A	OPT	N/A	OPT	N/A	OPT	N/A	OPT	•	N/A	N/A
Captains Chairs w/Removable Cushions	N/A	1	N/A	2	2	2	2	OPT	2	2	2	N/A
Captains Chair Foot Rest	N/A	•	N/A	•	•	•	•	•	•	•	•	N/A
Cockpit Table (Removable)	OPT	N/A	OPT	N/A	OPT	N/A	OPT	N/A	OPT	N/A	N/A	N/A
Console Seat/Front	•	N/A	•	N/A	•	N/A	•	N/A	•	•	•	•
Fishing Seat and Pedestal Pole Bow Mounted	N/A	N/A	N/A	N/A	N/A	N/A	N/A	N/A	N/A	N/A	OPT	OPT
Fishing Seat and Pedestal Pole Rear Mounted	N/A	N/A	N/A	N/A	N/A	N/A	N/A	N/A	N/A	N/A	OPT	OPT
L/P 2 Alum. W/Removable Back Rest & Rod Holders	OPT	N/A	OPT	N/A	OPT	N/A	OPT	N/A	OPT	OPT	OPT	N/A
L/P 3 Alum. W/Built-in Back Rest & Rod Holders	OPT	N/A	OPT	N/A	OPT	N/A	OPT	N/A	OPT	OPT	N/A	N/A
L/P 4 DLX. Fiberglass W/Fish Box & Cooler	N/A	N/A	N/A	N/A	N/A	N/A	OPT	•	OPT	N/A	N/A	N/A
L/P DLX. Fiberglass W/Tackle Storage & Premium Capt. Seats	OPT	N/A	OPT	N/A	OPT	N/A	OPT	N/A	OPT	N/A	N/A	N/A
Deluxe Leaning Post W/35 Gallon Livewell w/Backrest & Footrest	•	N/A	•	N/A	OPT	N/A	N/A	N/A	N/A	N/A	N/A	N/A
Passenger Side Lounge Seating	N/A	•	N/A	OPT	N/A	N/A	N/A	N/A	N/A	N/A	N/A	N/A

Features & Options

	320 CC	320 EXP	290 CC	270 WAC	270 CC	240 WAC	240 CC	220 WAC	220 CC	208 CC	2100 BAY	1900 BAY
STORAGE												
Anchor Locker	•	•	•	•	•	•	•	•	•	•	•	•
Battery Compartment	•	•	•	•	•	•	•	•	•	•	•	•
Cooler (25, 80, 72, 100 or 123 Qt.)	80/STD	OPT	80/STD	OPT	80/STD	OPT	80/STD	2-25/100	OPT	•	OPT	72/STD
AFT Removable Cooler (25, 80, 72, 100 or 123 Qt.)	123/OPT	123/OPT	80/OPT	80/OPT	80/OPT	80/OPT	80/OPT	2-25/OPT	N/A	N/A	N/A	72/STD
Deluxe Walk In Console / Lockable	•	N/A	•	N/A	•	N/A	•	N/A	•	N/A	N/A	N/A
In Console Storage (Lockable)	•	N/A	•	N/A	•	N/A	•	N/A	•	•	•	•
Insulated -Fish Box / Storage	4	1	4	1	2	2	2	1	2	2	1	1
Recessed SST Cup Holders	•	•	•	•	•	•	•	•	•	•	•	•
Recessed Rod Storage	•	•	•	•	•	•	•	•	•	•	•	•
Tackle storage	•	•	•	•	•	•	•	•	•	•	•	•
Recessed Tackle Box Additional One	N/A	N/A	N/A	OPT	OPT	OPT	OPT	N/A	OPT	OPT	N/A	N/A
Recessed Top Mounted Console Tackle Organizer	•	•	•	N/A	OPT	N/A	OPT	N/A	OPT	N/A	N/A	N/A
FISHING												
Bait Prep Station	•	•	•	•	OPT	•	OPT	•	•	•	N/A	N/A
Baitwell Standard / Aerated In Gallons	35/30	30	35 / 30	30	30	30	30	25	25	21	35	16
Cockpit Bolsters	•	•	•	•	•	•	•	•	•	•	N/A	N/A
DLX. T-Top With LED Spreader Light & Rod Holders	•	N/A	OPT	N/A	OPT	N/A	OPT	N/A	OPT	OPT	OPT	OPT
DLX. Hard Top W/LED Spreader Light, Electronic Box & Rod Holders	OPT	•	OPT	•	OPT	•	OPT	N/A	N/A	N/A	N/A	N/A
PFD Storage on Optional DLX. T-Top & Hard Tops	•	•	•	•	•	•	•	N/A	•	•	•	•
Pilot House Upgrade	N/A	OPT	N/A	OPT	N/A	OPT	N/A	N/A	N/A	N/A	N/A	N/A
Front & Side Curtains	OPT	OPT	OPT	OPT	OPT	OPT	OPT	OPT	OPT	OPT	OPT	OPT
Fish Finder / GPS / Garmin Electronics	OPT	OPT	OPT	OPT	OPT	OPT	OPT	OPT	OPT	OPT	OPT	OPT
Inset Toe Hold Rail	•	•	•	•	•	•	•	N/A	N/A	N/A	N/A	N/A
Outriggers For T-Top & Hard Tops Only/ N/A on Pilot House Tops	OPT	OPT	OPT	OPT	OPT	OPT	OPT	N/A	N/A	N/A	N/A	N/A
Splashwell Tool Holder & Raw Water Washdown Hose Holder	N/A	N/A	•	•	•	•	•	N/A	N/A	N/A	N/A	N/A
Poling Platform	N/A	N/A	N/A	N/A	N/A	N/A	N/A	N/A	N/A	N/A	OPT	OPT
Powder Coated Hardware (White or Black)	OPT	OPT	OPT	OPT	OPT	OPT	OPT	OPT	OPT	OPT	OPT	OPT
Release Livewell / Pro Red Fish Tournament Pack	N/A	N/A	N/A	N/A	N/A	N/A	N/A	N/A	N/A	N/A	•	•
Trolling Motor Plug w/Trim	N/A	N/A	N/A	N/A	N/A	N/A	N/A	N/A	N/A	OPT	•	•
BOAT												
Bimini Top With Boot	N/A	N/A	N/A	OPT	OPT	OPT	OPT	OPT	OPT	OPT	OPT	OPT
Console & Leaning Post Covers	OPT	N/A	OPT	N/A	OPT	N/A	OPT	N/A	OPT	N/A	N/A	N/A
Carbon Fiber Reinforced Deck	•	•	•	•	•	•	•	•	•	•	•	•
Closed Cell Foam Flotation	•	•	•	•	•	•	•	•	•	•	•	•
Colored Hull	•	•	•	•	•	•	•	•	•	•	•	•
Two Tone Colored Hulls	OPT	OPT	OPT	OPT	OPT	OPT	OPT	OPT	OPT	OPT	OPT	OPT
Boarding Ladder / Swim Platform	•	•	•	•	•	•	•	•	•	•	•	•
KEVLAR® Reinforced Hull	•	•	•	•	•	•	•	•	•	•	•	•
SailTech Composite Transom	•	•	•	•	•	•	•	•	•	•	•	•
SailTech Foam Filled Fiberglass Stringer System	•	•	•	•	•	•	•	•	•	•	•	•
Stainless Commander Steering Wheel (Hyd. Only)	•	•	•	•	•	•	•	•	•	•	•	•
Hydraulic Steering With Tilt Wheel	•	•	•	•	•	•	•	•	•	•	•	•
Power Assisted Hydraulic Steering	OPT	OPT	OPT	OPT	OPT	OPT	OPT	OPT	OPT	OPT	OPT	OPT
Trim Tabs / High Performance / Heavy Duty	HP/HD	HP/HD	HP	HP	HP	N/A	N/A	N/A	N/A	N/A	N/A	N/A
Trim Tabs With Indicator Switch	•	•	•	•	•	•	•	•	•	•	•	•
Wind Screen with Stainless Steel Grab Rail	N/A	N/A	•	N/A	•	N/A	•	N/A	•	•	•	•
Walk Thru Transom Door	•	•	•	•	•	•	•	•	•	N/A	N/A	N/A
Windlass w/Anchor Roller Assembly	OPT	•	OPT	OPT	OPT	OPT	OPT	N/A	N/A	N/A	N/A	N/A
Through the Hull Windlass w/Polished Anchor Roller Assembly	OPT	N/A	OPT	N/A	N/A	N/A	N/A	N/A	N/A	N/A	N/A	N/A
CABIN AMENITIES												
Cabin Butane Stove / Sink / Freshwater / Table	N/A	N/A	N/A	•	N/A	OPT	N/A	•	N/A	N/A	N/A	N/A
AC/DC Frig / Microwave / Shore Power	N/A	•	N/A	OPT	N/A	N/A	N/A	N/A	N/A	N/A	N/A	N/A
Cook Top Electric Eye	N/A	•	N/A	N/A	N/A	N/A	N/A	N/A	N/A	N/A	N/A	N/A
Air Conditioner / Shore Power	N/A	OPT	N/A	OPT	N/A	N/A	N/A	N/A	N/A	N/A	N/A	N/A
Hot Water Heater / Shore Power	N/A	•	N/A	OPT	N/A	OPT	N/A	N/A	N/A	N/A	N/A	N/A
Generator Power / Shore Power	N/A	OPT	N/A	OPT	N/A	N/A	N/A	N/A	N/A	N/A	N/A	N/A
Cabin Dinette Table	N/A	•	N/A	•	N/A	OPT	N/A	N/A	N/A	N/A	N/A	N/A
Cabin Ice Box	N/A	N/A	N/A	•	N/A	N/A	N/A	•	N/A	N/A	N/A	N/A
Cabin V-Berth Cushions and Filler Cushions	N/A	•	N/A	•	N/A	OPT	N/A	•	N/A	N/A	N/A	N/A
Flip-Up Bunk Bed Option	N/A	•	N/A	•	N/A	N/A	N/A	N/A	N/A	N/A	N/A	N/A
Mid-Ship Berth Bed & Storage	N/A	•	N/A	N/A	N/A	N/A	N/A	N/A	N/A	N/A	N/A	N/A

Optional Packages

320CC: CRUISE PACKAGE: Bow Cushions Bottoms, Stereo w/Remote Control, Satellite Radio Upgrade & Removable Bow Table

320 Express: OVER NIGHT PACKAGE: Generator EFI 3KW & Air Conditioner; **PILOT HOUSE PACKAGE:** Hard Top with Hard Frame Windshield W/Wipers & Back Drop Curtains

290CC: PRO FISHING PACKAGE: Colored Hull, Fender Cleats & Netting Package; **COMFORT PACKAGE:** Rear Jump Seats, Bow Cushion Bottoms & Bow Bolsters Netting; **ENTERTAINMENT PACKAGE:** Ski Tow Bar, Removable Bow Table, Stereo w/Satellite Radio Upgrade & LED Underwater Lighting; **OFFSHORE TOURNAMENT PACKAGE I:** T-Top, Flush Mount Cleats & Bow Light, Transom Rod Holders; **OFFSHORE TOURNAMENT PACKAGE II:** Deluxe Hard Top, Flush Mount Cleats & Bow Light, Transom Rod Holders; **OFFSHORE TOURNAMENT PACKAGE III:** Ladder Back Hard Top, Flush Mount Cleats & Bow Light, Transom Rod Holders

270WAC: POWER PACKAGE: Shore Power, Built-In Battery Charger, Refrigerator & Microwave; **CRUISE PACKAGE:** Rear Jump Seat, Rear Cooler Seat & Satellite Radio Upgrade; **TOURNAMENT PACKAGE:** Hard Top with Built-In Radio Box & 2nd Tackle Organizer; **PILOT HOUSE PACKAGE:** Hard Top w/Hard Frame Windshield, Wipers & Back Drop Curtains

270CC: PRO FISHING PACKAGE: Colored Hull, Vanity Storage, Fender Cleats & Netting Package; **COMFORT PACKAGE:** Rear Jump Seats, Bow Cushion Bottoms & Bow Bolsters; **ENTERTAINMENT PACKAGE:** Ski Tow Bar, Removable Bow Table, Stereo w/Satellite Radio Upgrade & LED Underwater Lighting; **OFFSHORE TOURNAMENT PACKAGE I:** T-Top, Flush Mount Cleats & Bow Light & Transom Rod Holders; **OFFSHORE TOURNAMENT PACKAGE II:** Deluxe Hard Top, Flush Mount Cleats & Bow Light, Transom Rod Holders; **OFFSHORE TOURNAMENT PACKAGE III:** Ladder Back Hard Top, Flush Mount Cleats & Bow Light, Transom Rod Holders & 35 GAL. Leaning Post

240WAC: PRO FISHING PACKAGE: Colored Hull, Fender Cleats & Trim Tabs with Indicator Switch; **CRUISE PACKAGE:** Rear Jump Seats, Rear Cooler Seat & Cabin Table with Pedestal & Cushion; **TOURNAMENT PACKAGE:** Hard Top w/Built-In Radio Box, Flush Mounted Cleats & Transom Rod Holders; **PILOT HOUSE PACKAGE:** Hard Top w/Hard Frame Windshield, Wipers, Back Drop Curtains & Window Defroster

240CC: PRO FISHING PACKAGE: Colored Hull, Vanity Storage, Fender Cleats, Netting Package & Trim Tabs w/ Indicator Switch; **COMFORT PACKAGE:** Rear Jump Seats, Bow Cushion Bottoms & Bow Bolsters; **OFFSHORE TOURNAMENT PACKAGE:** T-Top, Flush Mount Cleats & Bow Light, Transom Rod Holders; **ENTERTAINMENT PACKAGE:** Ski Tow Bar, Removable Bow Table, Stereo w/Satellite Radio Upgrade & LED Underwater Lighting

220WAC: PRO FISHING PACKAGE: Colored Hull, Fender Cleats & Trim Tab Indicator Switch; **OFFSHORE TOURNAMENT PACKAGE:** Hard Top with Built-In Radio Box, Flush Mounted Cleats & Transom Rod Holders

220CC: PRO FISHING PACKAGE: Colored Hull, Fender Cleats, Netting Package & Trim Tabs w/Indicator Switch; **COMFORT PACKAGE:** Rear Jump Seats, Bow Cushion Bottoms & Bow Bolsters; **OFFSHORE TOURNAMENT PACKAGE:** T-Top, Flush Mounted Cleats, Flush Mounted Bow Light & Transom Rod Holders; **ENTERTAINMENT PACKAGE:** Ski Tow Bar, Removable Bow Table & Stereo w/Satellite Radio

208CC: Comfort Package: Bow Cushion Bottoms & Helm Cooler Seat w/Backrest Depth; **PRO FISHING PACKAGE:** Colored Hull & Trim Tabs w/Indicator Switch; **OFFSHORE TOURNAMENT PACKAGE:** T-Top, Flush Mounted Cleats & Bow Light

2100 BB: SPORT PACK: Trolling Motor Panel, 2 Additional Rod Holders & Rear Jump Seat Cushions; **PRO FISH PACK I:** (Includes Sport Pack), LP2 w/Backrest, Colored Hull, Front Jump Seat Cushions & Flush Mounted Cleats; **PRO FISH PACK II:** (Includes Sport Pack), SST Flip Flop Cooler seat, Colored Hull, Front Jump Seat Cushions & Flush Mounted Cleats; **INSHORE TOURNAMENT PACK:** Built-In Battery Charger & Casting Deck Fishing Seat

1900 BB: SPORT PACK: Trolling Motor Panel, 2 Additional Rod Holders & Rear Jump Seat Cushions; **PRO FISH PACK:** (Includes Sport Pack), Colored Hull, Front Jump Seat Cushions & Flush Mounted Cleats; **INSHORE TOURNAMENT PACK:** Built-In Battery Charger & Casting Deck Fishing Seat

Optional Seating Arrangements

Choose your level of comfort and seating capacity with Sailfish's wide array of seating options – helm seats, leaning posts, front helm seats, lounges and aft seating all designed to deliver the perfect combination of comfort and functionality.



A Capt. Chairs Standard on 2100BB, 208CC, 220CC, 240CC and 270CC



B Optional 40" AFT Folding Seat for 240CC, 240WAC, 270CC, 270WAC, 290CC (320CC and EXP 58")



C Standard Capt. Chair for 320 Express



D Standard 1900BB Cooler Seat



E Optional 2100BB Flip Flop Cooler



F Standard Capt. Chair on 270WAC



G Standard 220CC Front Helm Seat



H Optional Leaning Post for 1900BB



I Standard 240CC Front Helm Seat

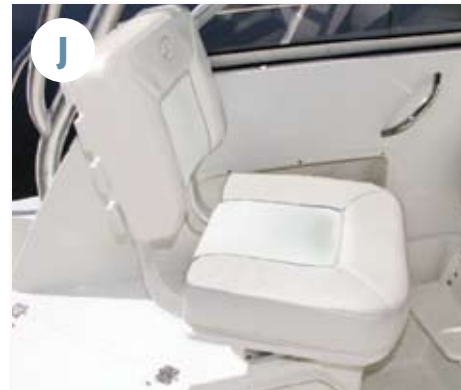

J Standard Passenger Side Capt. Chair on 270WAC

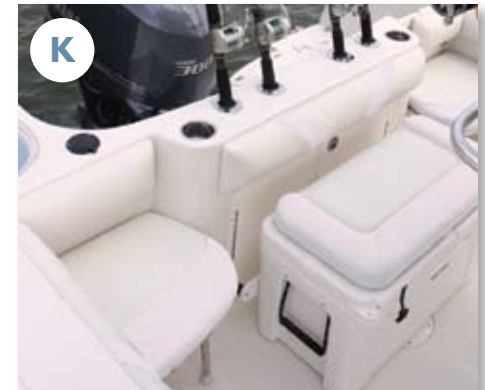

K Optional AFT Seating for 240CC, 240WAC, 270CC, 270WAC, 290CC

Select Your Comfort Level



Optional Deluxe Capt. Chairs and Tackle Storage for 270CC, 290CC and 320CC



Optional Leaning Post with 35 Gallon Livewell and Optional Tackle Storage for 270CC, (Standard on 290CC & 320CC)



Standard Front Cooler Seat for 270CC, 290CC and 320CC



Standard 220WAC Leaning Post with Cooler, Optional 220CC, 240CC & 270CC



Optional Leaning Post for 2100BB, 208CC, 220CC, 240CC and 270CC



Optional Leaning Post for 240CC and 270CC

Hull Colors

Make your Sailfish your own with eight exciting color gelcoats to choose from, each masterfully applied and polished to the brightest possible shine. Solid color or two-tone gelcoat hulls are available.

Standard Colors

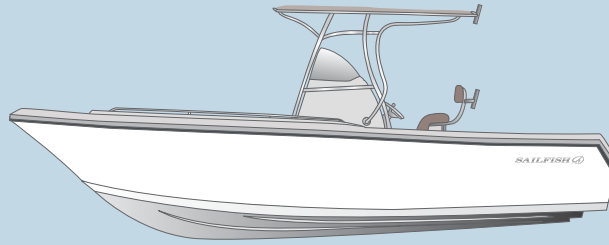

White Standard



Deep Blue

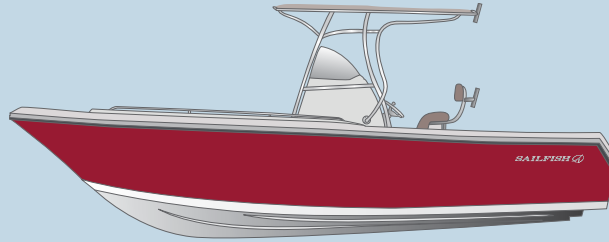

Burgundy

Legacy Colors

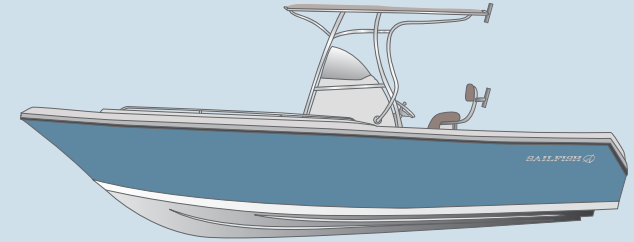

Slate Blue

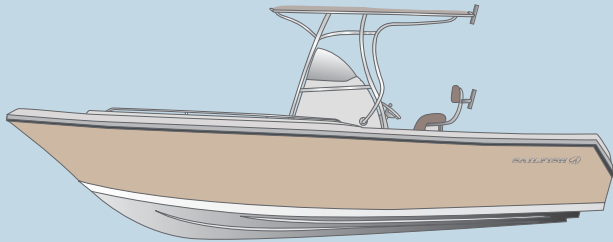

Bronze

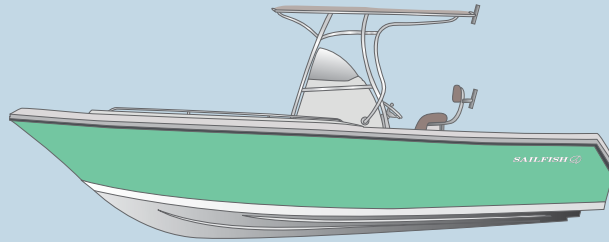

Haven Green

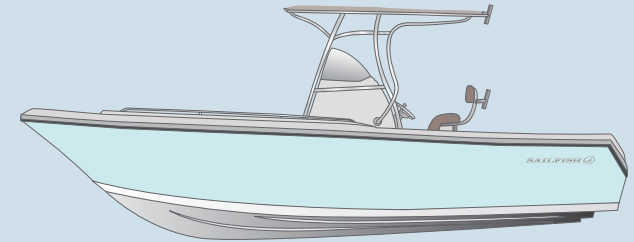

Ice Blue



Black



Burnt Orange

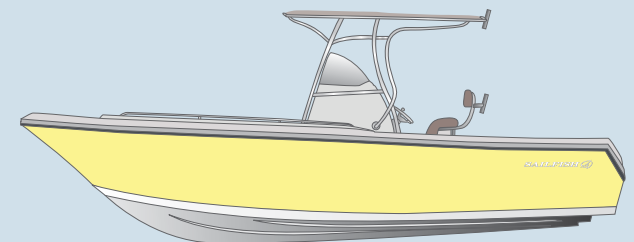

Fighting Lady Yellow

SAILFISH[®]





Scan to Visit
Our Website!



Manufactured by

SEMINOLE MARINE GROUP

2501 Industrial Park Drive • Cairo, GA 39828 • 229.377.2125

w w w . S a i l f i s h b o a t s . c o m

Seminole Marine, Inc. reserves the right to discontinue models or change prices, specifications, materials, equipment, color or design at any time without incurring obligation. Weight and dimensions of all models are approximate and may vary. Options are subject to change. Photographs in this catalog were shot under supervised conditions with professional models and drivers and boats shown may contain optional equipment.